



B7° 30 / 1,2
B7

4 16 / 2,1
3 15 / 2,1
5 7 / 1,8
7 18 / 4,7
9

THIS INFORMATION MAY NOT BE COPIED BY A
THIRD PARTY, SUBJECT TO COPYRIGHT (PANA-
GRAPH 1 NO. 3 OF UHREBERRECHTSGESETZ
FROM 14.06.1991)

 Waltinger Baumaschinen Vertrieb und Service GmbH		FREE DIMENSION		 SCALE
		TOLEANCE DIN 7169		
DATE		NAME		Seite 1 control panel V4 Page 1
DRAWN: 2002/03/27		PAPER		
CHECK: APPR:				
CHANGE ONLY WITH CAD		REPLACEMENT FOR		B 51 3 017
REPLACEMENT BY		REPLACEMENT BY		

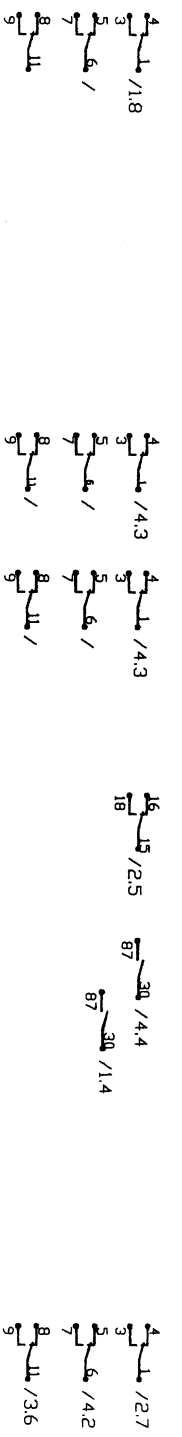
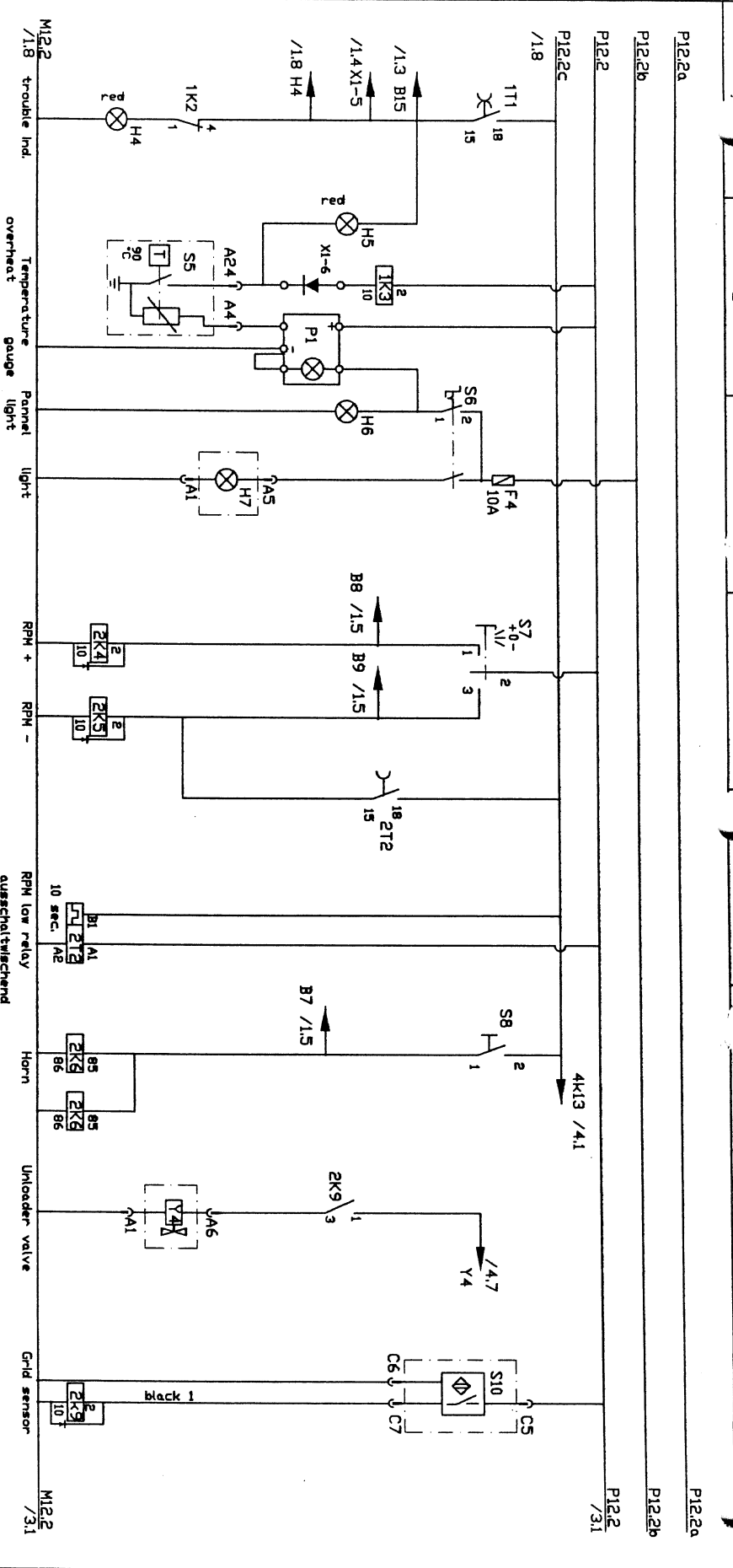

THIS INFORMATION MAY NOT BE COPIED BY A THIRD PARTY, SUBJECT TO COPYRIGHT (PAM-GRAPH 1 NO. 3 OF UNRECHTSSETZ FROM 14.06.1991)

		Wolfringer Bauteile Vertrieb und Service GmbH		FREE DIMENSION TOLERANCE DIN 7189 MEDIUM				SCALE	WEIGHT
				DATE		NAME		Seite 2	
				DATE		NAME		control panel V4	
				DATE		NAME		Page 2	
				DATE		NAME		B 51 3 017	
				DATE		NAME		REPLACEMENT FOR	
				DATE		NAME		REPLACEMENT BY	
				DATE		NAME		SHEET	
				DATE		NAME		of	

P12.3a P12.3b P12.3c

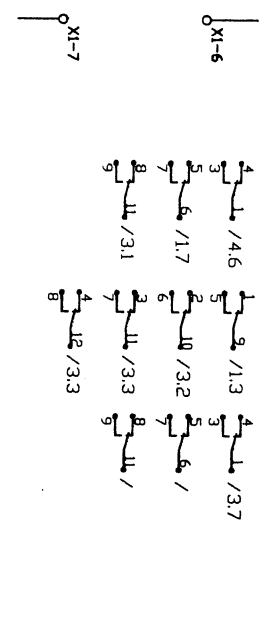
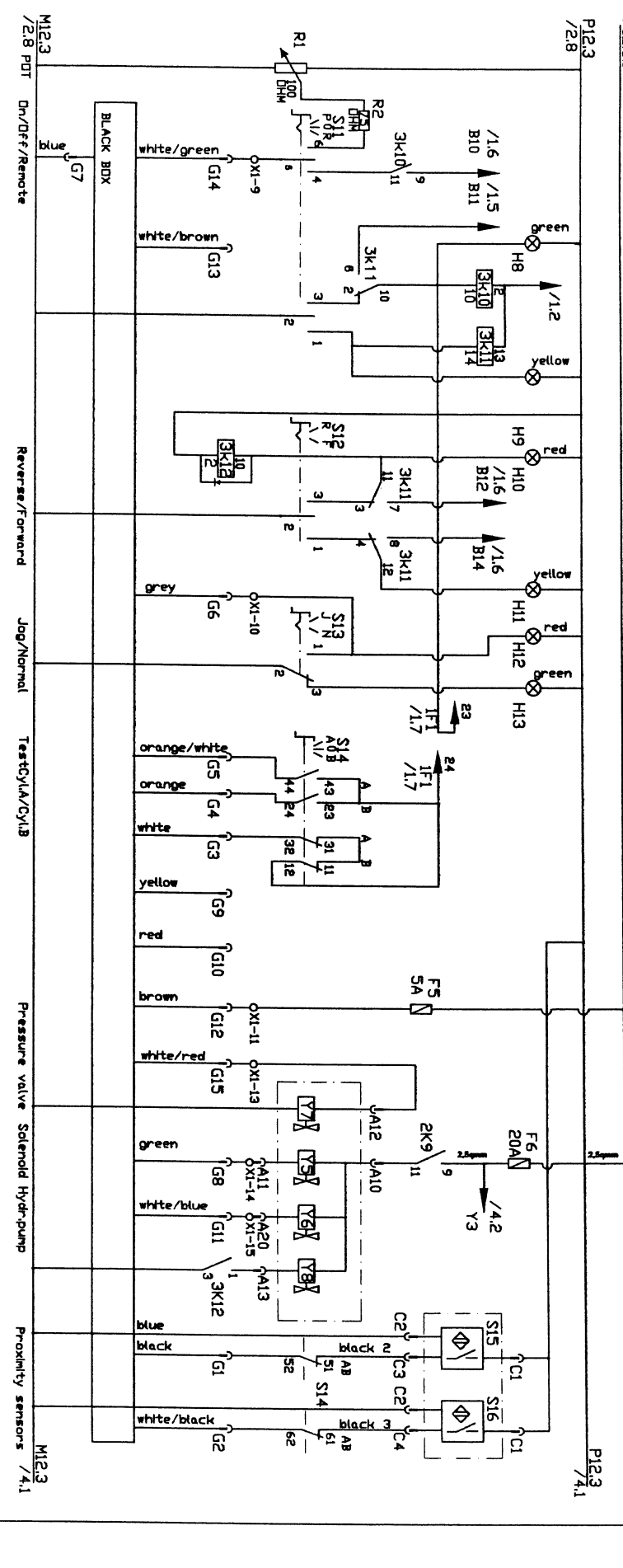

THIS INFORMATION MAY NOT BE COPIED BY A THIRD PARTY, SUBJECT TO COPYRIGHT (PANA-GRAPH 1 NO. 3 OF URHEBERRECHTSSESZETZ FROM 14.06.1997)

		DATE		NAME	
		DATE	NAME	DATE	NAME
FREE DIMENSION TOLERANCE DIN 7168 MEDIUM		DATE	NAME	CHANGE ONLY WITH CAD	
Woltzinger Baumaschinen Vertrieb und Service GmbH		DATE	NAME	B 51 3 017	
SCALE		DATE	NAME	REPLACEMENT FOR	
Seite 3		DATE	NAME	REPLACEMENT BY	
control panel V4		DATE	NAME	SHEET	
Page 3		DATE	NAME	OF	

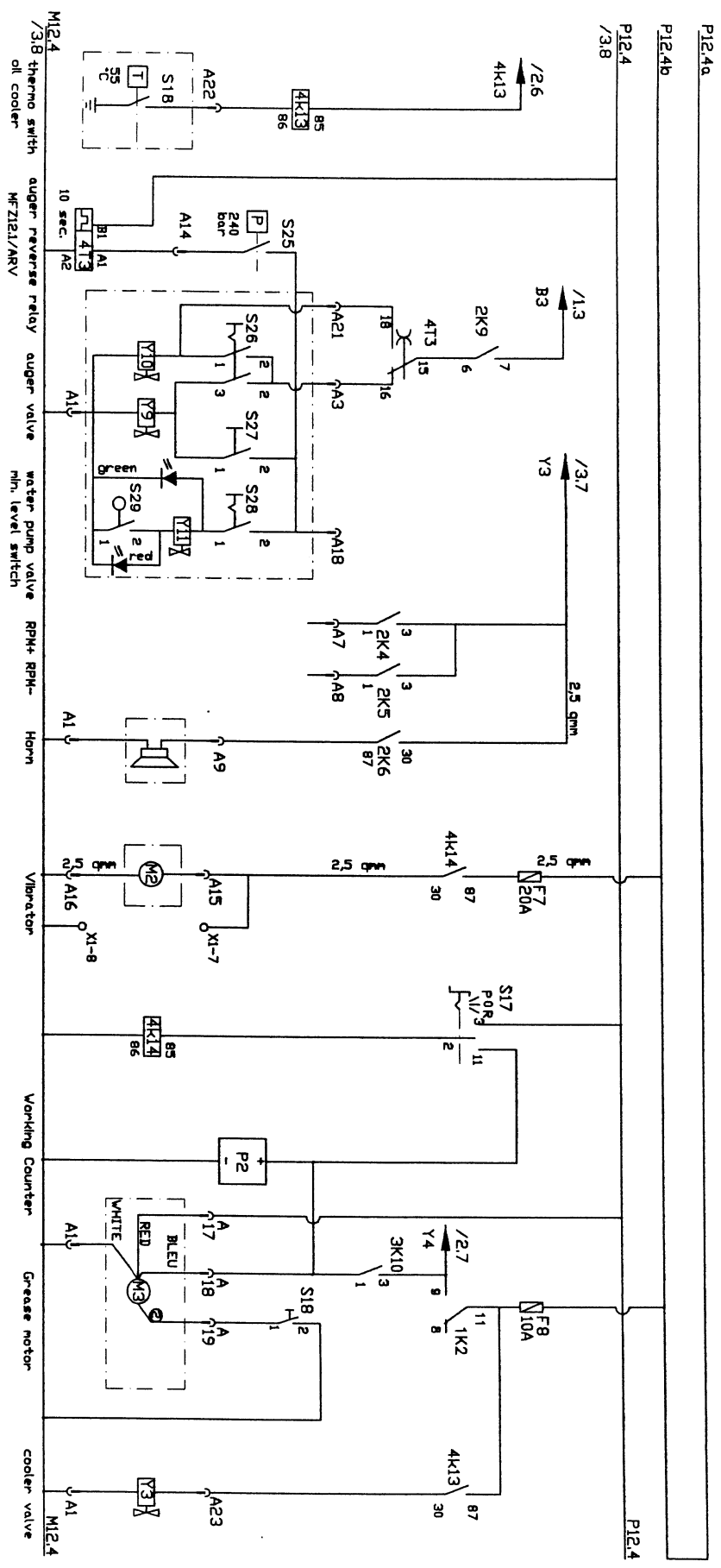

B7c 30 / 4.8
87

16 15 / 4.2
18

B7c 30 / 4.4
87

THIS INFORMATION MAY NOT BE COPIED BY A
THIRD PARTY, SUBJECT TO COPYRIGHT (PANA-
GRAPH 1 NO. 3 OF "UNTERSRECHTSSEITZ"
FROM 14.06.1991)

		FREE DIMENSION		SCALE	
		DIN 7169		HEIGHT	
Wöhlhager Baumaschinen Vertrieb und Service GmbH		DATE: 1990/03/27 NAME:		Seite 4 control panel V4 Page 4	
DATE: 12.01.04 NAME:		DATE: 1990/03/27 NAME:			
b 1200 12.01.04 d 1200 12.01.04		CHANGE ONLY WITH CAD		REPLACEMENT FOR: B 51 3 017	
REPLACEMENT BY:		SHEET OF:		REPLACEMENT BY:	

pos	description	ident-no	DIN	change-index	chg. dat	weight	quant
	stock	dimensions	material	valid from	val. unt.		unit

1	emergency stop switch	WAI105094				0.000	1.00 stk
2	contact block	WAI105095				0.000	1.00 stk
3	label ZB2-BY9330	WAI102278				0.000	1.00 stk
4	lamp 12V	WAI104083				0.100	1.00 stk
5	led-signal lamp, red	WAI105811				0.000	4.00 stk
6	led-signal lamp, yellow	WAI105812				0.000	2.00 stk
7	led-signal lamp, green	WAI105813				0.000	3.00 stk
8	lever switch MOM-OFF-MOM	WAI103976				0.000	1.00 stk
9	lever switch ON-OFF-ON	WAI104090				0.000	2.00 stk

description	drawing-no	ID	date	chg.-index	chg-date	val.from	val.unt
control panel WAI 106059 Version 4	B513017	M1	07.02.01	1b	02.02.04		

pos	description	ident-no	DIN	change-index	chg. dat	weight	quant
	stock	dimensions	material	valid from	val. unt.		untl

10	lever switch MOM-ON	WAI104091				0.000	2.00
							Stk
11	lever switch ON-OFF	WAI104089				0.000	2.00
							Stk
12	lever switch ON-OFF, 2-poles	WAI104092				0.100	2.00
							Stk
13	relay 3W, 12VDC	WAI104093				0.000	7.00
							Stk
14	socket 11-poles	WAI104859				0.000	2.00
							Stk
15	relais socket 10A, 380V, 1ipIn	WAI100178				0.000	5.00
							Stk
16	clip for relay	WAI104094				0.000	7.00
							Stk
17	fuse box	WAI101577				0.000	1.00
							Stk
18	fuse 5 A	WAI101922				0.000	1.00
							Stk

description	drawing-no	ID	date	chg.-index	chg-date	val.from	val.untl
control panel WAI 106059 Version 4	B513017	MI	07.02.01	b	02.02.04		

pos	description	ident-no	DIN	change-index	chg. dat	weight	quant
	stock	dimensions	material	valid from	val.unt.		unit

19	fuse 10 A	MA1101921				0.000	3.00
							stk
20	fuse 20 A	MA1104096				0.000	2.00
							stk
21	operating hours counter	MA1100900				0.000	1.00
							stk
22	housing with 2 bows, 16-pol.	MA1104097				0.000	1.00
							stk
23	plug insert 1-16 pin	MA1104022				0.000	1.00
							stk
24	housing-body, lower part 24-pol	MA1101533				0.000	1.00
							stk
25	socket insertion 24-pol.	MA1100710				0.000	1.00
							stk
26	earth terminal block	MA1102577				0.000	1.00
							stk
27	bag for circuit diagram	MA1104099				0.000	1.00
							stk

description	drawing-no	ID	date	chg.-index	chg-date	val. from	val.unt.
control panel WAI 106059 Version 4	BS13017	M1	07.02.01	b	02.02.04		

pos	description	ident-no	DIN	change-index	chg. dat	weight	quant
	stock	dimensions	material	valid from	val.unt.		unit

28	rubber cushion 25 x 20	WA1104100				0.000	4.00 stk
29	distributor system	WA1105998				0.000	1.00 stk
30	bulb 12V, 5W	WA1104101				0.100	3.00 stk
31	potentiometer	WA1104103				0.000	1.00 stk
32	potentiometer housing	WA1104104				0.000	1.00 stk
33	fittng PG21	WA1104109				0.000	1.00 stk
34	fittng PG11	WA1104110				0.000	1.00 stk
35	lock nut PG21	WA1104114				0.000	1.00 stk
36	plug	WA1106395				0.000	1.00 stk

description	drawing-no	ID	date	chg.-index	chg-date	val. from	val. until
control panel WAI 106059 Version 4	BS13017	M1	07.02.01	b	02.02.04		

pos	description	ident-no	DIN	change-index	chg. dat	weight	quant
	stock	dimensions	material	valid from	val.unt.		unit

37	relay DC 12V	WA1104117				0.000	4.00
							stk
38	relay socket	WA1100986				0.000	4.00
							stk
39	lock nut PG11	WA1104112				0.000	1.00
							stk
40	relay 12VDC, 70A	WA1104122				0.000	1.00
							stk
41	socket for relay	WA1105619				0.000	1.00
							stk
42	fittng PG16 Nickel	WA1102933				0.000	1.00
							stk
43	resistance 100 Ohm	WA1104118				0.000	2.00
							stk
47	clamp	WA1105817				0.000	2.00
							stk
48	end- and distance plate orange	WA1105818				0.000	1.00
							stk

description	drawing-no	ID	date	chg.-index	chg-date	val.from	val.untl
control panel WAI 106059 Version 4	B513017	M1	07.02.01	b	02.02.04		

pos	description	ident-no	DIN	change-index	chg. dat	weight	quant
	stock	dimensions	material	valid from	val.unt.		unit
49	rotary buton	WAI100968				0.000	1.00 Stk
50	holder	WAI100287				0.000	1.00 Stk
51	switch element	WAI100969				0.000	3.00 Stk
52	brldge	WAI103735				0.000	2.00 Stk
53	relay DC 12V 14 ports	WAI105046				0.000	1.00 Stk
54	condenser	WAI104669				0.000	1.00 Stk
55	clamp	WAI104186				0.000	6.00 Stk
56	plug with diode	WAI104185				0.000	5.00 Stk
57	crimp contact 0,75 - 1 qmm male	WAI103695				0.000	2.00 Stk

description	drawing-no	ID	date	chg.-index	chg-date	val. from	val. unti
control panel WAI 106059 Version 4	B513017	MI	07.02.01	b	02.02.04		

pos	description	ident-no	DIN	change-index	chg. dat	weight	quant
	stock	dimensions	material	valid from	val. unt.		unit

59	time - relais	WAI105331				0.000	1.00
							Stk
60	relay EZ	WAI105815				0.000	1.00
							Stk
61	emergency switch element PNOZ X5	WAI105814				0.000	1.00
							Stk
62	label for control panel	WAI105819				0.000	1.00
							Stk
63	clamp	WAI104671				0.000	2.00
							Stk
64	socket 14-poles	WAI103974				0.020	1.00
							Stk
65	clip for relay	WAI104860				0.020	1.00
							Stk
66	thermometer for control panel	WAI105823				0.000	1.00
							Stk
67	black box	WAI104442				0.000	1.00
							Stk

description	drawing-no	ID	date	chg.-index	chg-date	val. from	val. unit
control panel WAI 106059 Version 4	B513017	M1	07.02.01	b	02.02.04		

pos	description	ident-no	DIN	change-index	chg. dat	weight	quant
	stock	dimensions	material	valid from	val. unt.		unit

68	nut CE 16	WAI104519				0.000	1.00
							Stk
69	lamp	WAI106402				0.000	1.00
							Stk
71	time - relais	WAI106393				0.000	1.00
							Stk
72	lamp	WAI106182				0.000	1.00
							Stk

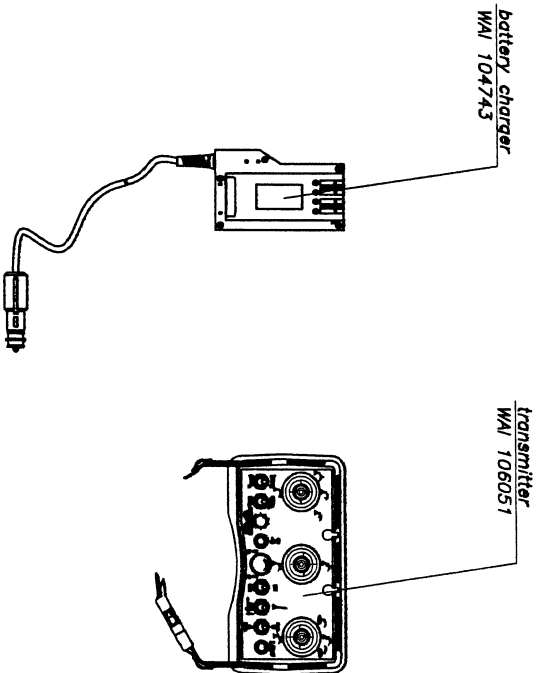
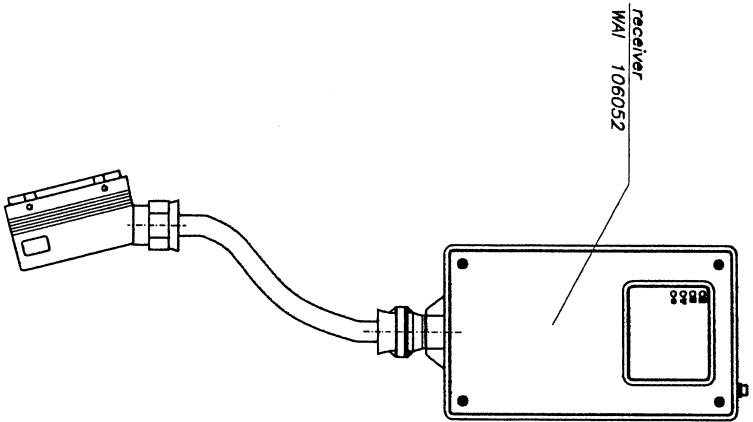

description	drawing-no	ID	date	chg.-index	chg-date	val.from	val.untl
control panel WAI 106059 Version 4	B513017	M1	07.02.01	p	02.02.04		

*** Liste beendet am 19/04/04/10.52 ***



by ordering from receiver or transmitters
the serial no. of the unit must be mentioned

this information may not be copied by a
third party. Subject to copyright (con-
graph 1 no. 3 of Urheberrechtsgesetz-
from 14.06.1981)

 Waltzinger Baumaschinen Vertrieb und Service GmbH		free dimension		 name	scale	1:5	weight	00 N
		tolerance DIN 7188	medium					
date	name	change only with CAD	replacement Nr	replacement by	sheet	of		
AKOBRICHON			WAI 105982					

S. U C K L I S T E N - D R U C K

pos	description	ident-no	DIN	change-index	chg. dat	weight	quant
	stock	dimensions	material	valid from	val. unt.		untl

1	transmitter for remote control Reed 6	WA1106051				0.000	1.00
	-order only with plant number possible-						Stk
2	receiver for remote control REED 6	WA1106052				0.000	1.00
	-order only with plant number possible-						Stk
3	battery charger PNN-System	WA1104743				0.000	1.00
							Stk
4	accumulator for remote control	WA1104745				0.000	1.00
							Stk

description	drawing-no	ID	date	chg.-index	chg-date	val. from	val. untl
radio control	WA1105982	MI	16.03.00				

*** Liste beendet am 19/04/04/11.09 ***

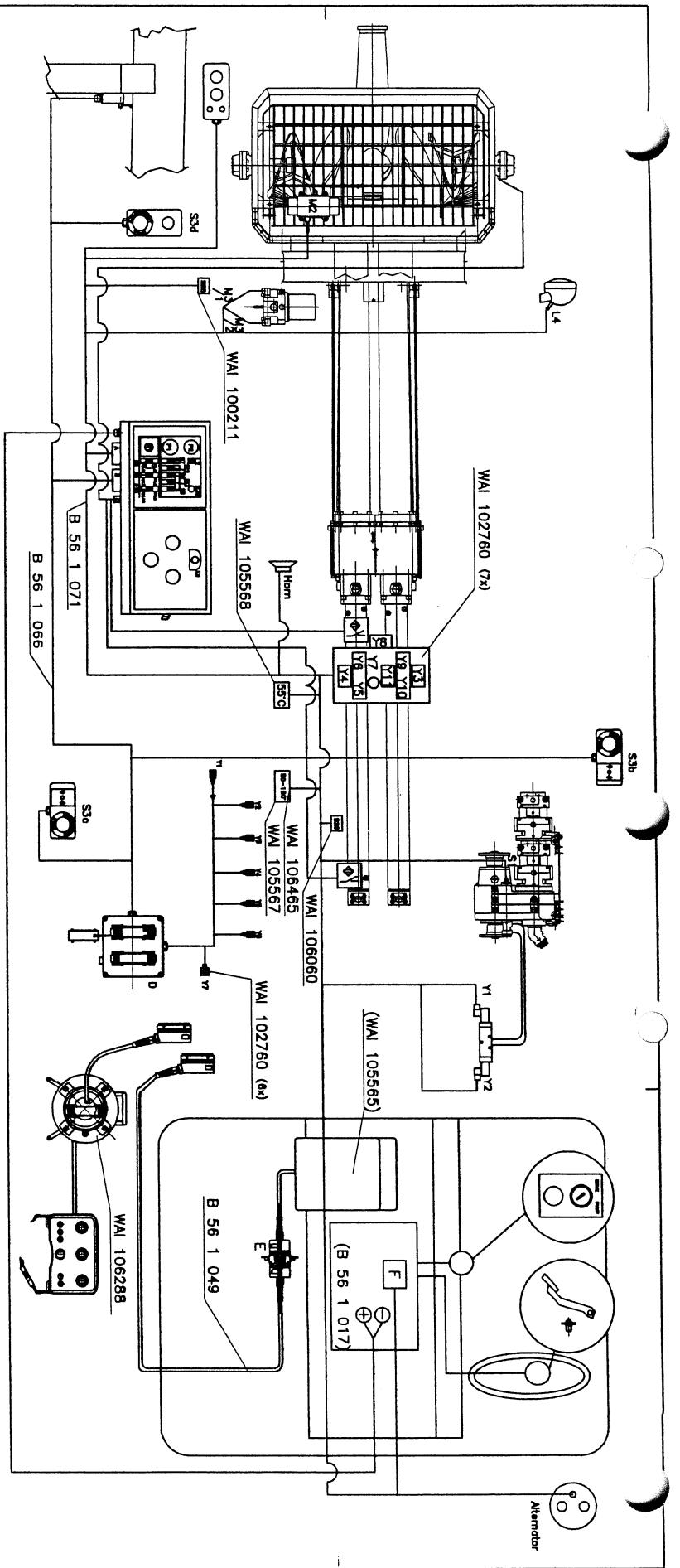

PLUG A

1	Y4+Y7+FMN	brn
2	Y4+Y7+FMN	blk/whi
3	Y3+Y1	red/yel
4	temp. switch	yel/whi
5	Y4-1	grn/whi
6	Y4-1	blu/whi
7	F3	blu
8	F2	blk
9	Horn	blk
10	Y5-1/hoppar	blk/grn
11	Y6/Y8/Y9	blk/red
12	Y2-1	grn/red
13	Y8	whi/brn
14	Y9	vio
15	M2	blk
16	M2	blu
17	M3/1-1	grn
18	M3/1-3	yel
19	M3/2-2	whi
20	Y6	whi
21	temp switch	whi
22	temp switch	whi
23	Y10	grn
24	free	free
F5	red	red
F6	grn/blk	grn/blk

PLUG B

1	D10-blk	brn	ground
2	S3b	grn	emergency stop
3	S3c	blk	emergency stop
4	D13	blu	emergency stop
5	D 22	grn/red	emergency stop
6	S3b-d	white	emergency stop
7	D 20	whi/grn	horn
8	D 15	grn	RPM +
9	D 16	blk/whi	RPM -
10	D 24	vio	Pol
11	D 17	blk/grn	pumping on
12	D 19	grn/blk	reverse
13	free	free	free
14	D 18	blu/whi	pumping
15	D 21	blk/red	flushing light
16	free	free	free

PLUG C

pin No.	wire No.	function
1	1	brown +
2	2	black
3	3	black
4	4	Sensor 1
5	5	Sensor 2
6	6	stop
7	7	stop
8	8	stop

PLUG D

pin No.	wire No.	function
1	Y3/3	brn
2	Y3/3	brn/whi
3	Y4/3	blu
4	Y4/3	grn/whi
5	Y4/2	blk/grn
6	Y8/2	blk/whi
7	Y8/2	blk/whi
8	Y8/2	grn/red
9	free	free
10	-lll	brn
11	Y2/2	vio
12	Y2/3	blu/whi
13	B4	red
14	Y1/2/3	grn
15	B 8	grn
16	B 9	blk/whi
17	B 11	blk/grn
18	B 14	blu/whi
19	B 12	grn/blk
20	B 7	whi/grn
21	B 15	blk/red
22	B 5	grn/red
23	17	brn/whi
24	B 10	vio

PLUG E

pin No.	wire No.	function
1	1	power supply 12V
2	2	emergency stop
3	3	12 V+
4	4	RPM-
5	5	free
6	6	horn
7	11	RPM+
8	13	horn
9	9	OXD
10	14	reverse
11	25	pilot valve
12	-	free
13	-	free
14	-	free
15	-	free
16	33	boom 4 down
17	34	boom 4 up
18	31	boom 3 down
19	32	boom 3 up
20	29	turn clockwise
21	30	turn anticlockwise
22	28	boom 1 down
23	27	boom 1 up
24	39	boom 2 down
25	40	boom 2 up
26	-	free
27	-	free
28	35	pump speed pot
29	-	free
30	-	free
31	-	free
32	-	free

TERMINAL F

1	whi	Y1
2	grn	Y2
3	grn/whi	Y3
4	blu	Y4
5	blk	Y5
6	whi	Y6
7	brn	Y7
8	blk	Y8
9	red	Y9
10	grn/blk	Y10
11	free	Y11
12	free	Y12

W Walsenburg
Walsenburg
Vertrieb und
Service GmbH

FREE PAKINGSON
DIN 7165
M20/M4

DATE: _____ NAME: _____
DRAWN: _____ IN: _____
CHECK: _____ APPR: _____

CHANGE ONLY WITH CAD

Cable harness /
accessories REED V4

B 56 1 070

REPLACEMENT FOR: _____ REPLACEMENT BY: _____

SCALE: without

NOTE: own parts list

THIS INFORMATION MAY NOT BE COPIED BY A
THIRD PARTY, SUBJECT TO COPYRIGHT (PUBLISHED
BY REED) AND IS THE PROPERTY OF WALSUNBERG
FROM 14.06.1991

pos	description	ident-no	DIN	change-index	chg. dat	weight	quant
stock		dimensions	material	valid from	val. unt.		unit

1	cable harness boom REED V III own parts list	B561066		a	28.03.00	9.000	1.00
2	cable harness pump REED CL 32/36 V IV own parts list	B561071				0.000	1.00
3	cable cpl. for cable control own parts list	B561049				0.000	1.00
4	cable drum + 35m cable (34 x 0,5) own parts list	WA1106288				0.000	1.00
5	anti-interference device	WA1102760				0.000	13.00
6	thermo sensor 90 degrees C	WA1105567				0.100	1.00
7	thermo sensor 55 degrees C	WA1105568				0.100	1.00
8	pressure switch for spare function	WA1100211				0.874	1.00
9	switch swimmer	WA1106060				0.000	1.00

description	drawing-no	ID	date	chg.-index	chg-date	val. from	val. unti
cable harness closed loop version IV	B561070	MI	28.03.00				

pos	description	ident-no	DIN	change-index	chg. dat	weight	quant
	stock	dimensions	material	valid from	val. unt.		unit

10	sealing ring 14x18x2	WA1106465				0.000	1.00
							Stk

description	drawing-no	ID	date	chg.-index	chg-date	val.from	val.untl
cable harness closed loop version IV	B561070	MI	28.03.00				

*** Liste beendet am 22/04/04/08.14 ***