

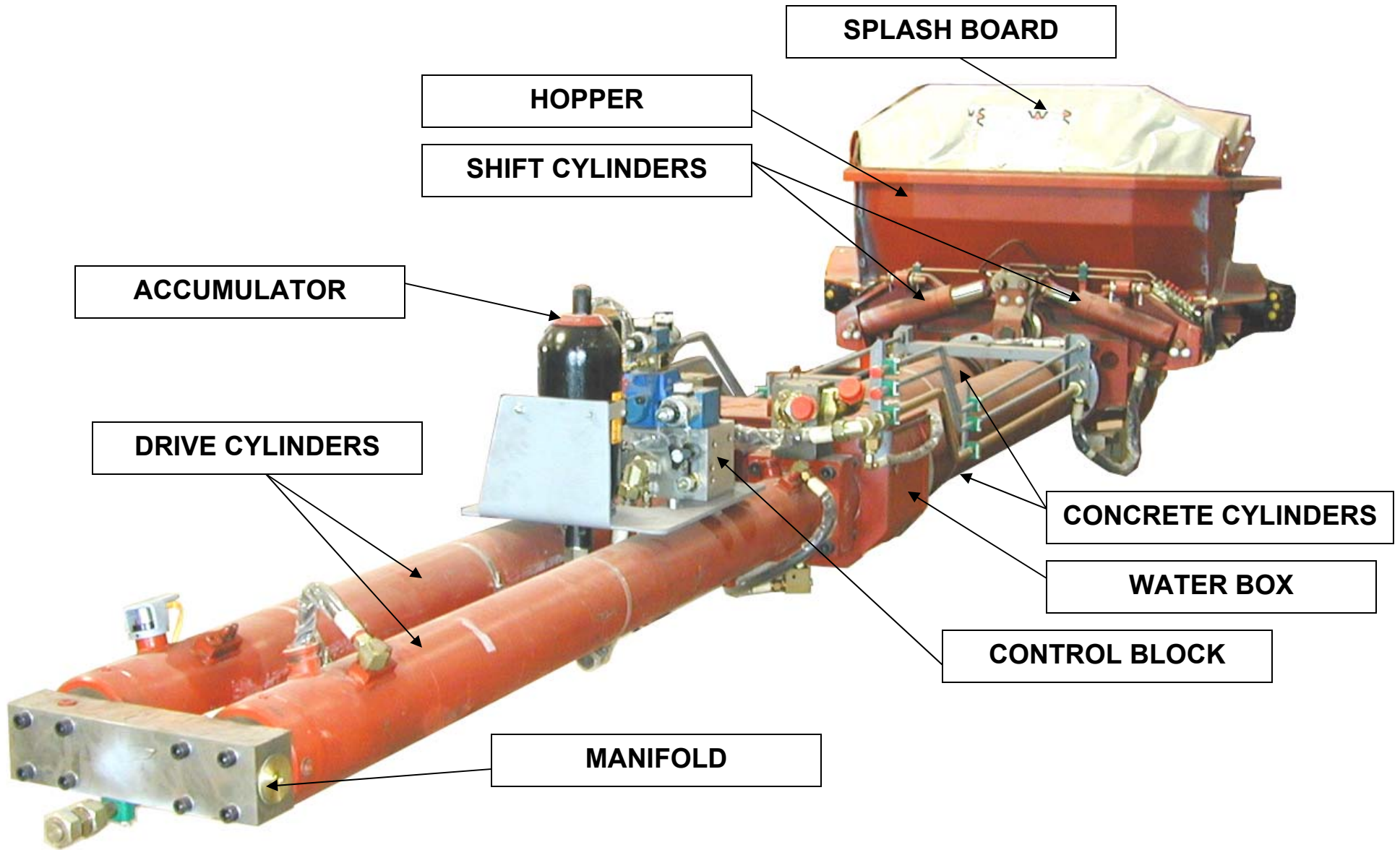

PUMP CELL-CLOSED LOOP-ASSEMBLY PROCEDURES
REED MODELS – XXT37/XXT42



PUMP CELL-CLOSED LOOP-ASSEMBLY PROCEDURES-PG 1 OF 29
REED MODELS – XXT37/XXT42



GENERAL ASSEMBLY-DESCRIPTIONS

PUMP CELL-CLOSED LOOP-ASSEMBLY PROCEDURES-PG 2 OF 29
REED MODELS – XXT37/XXT42

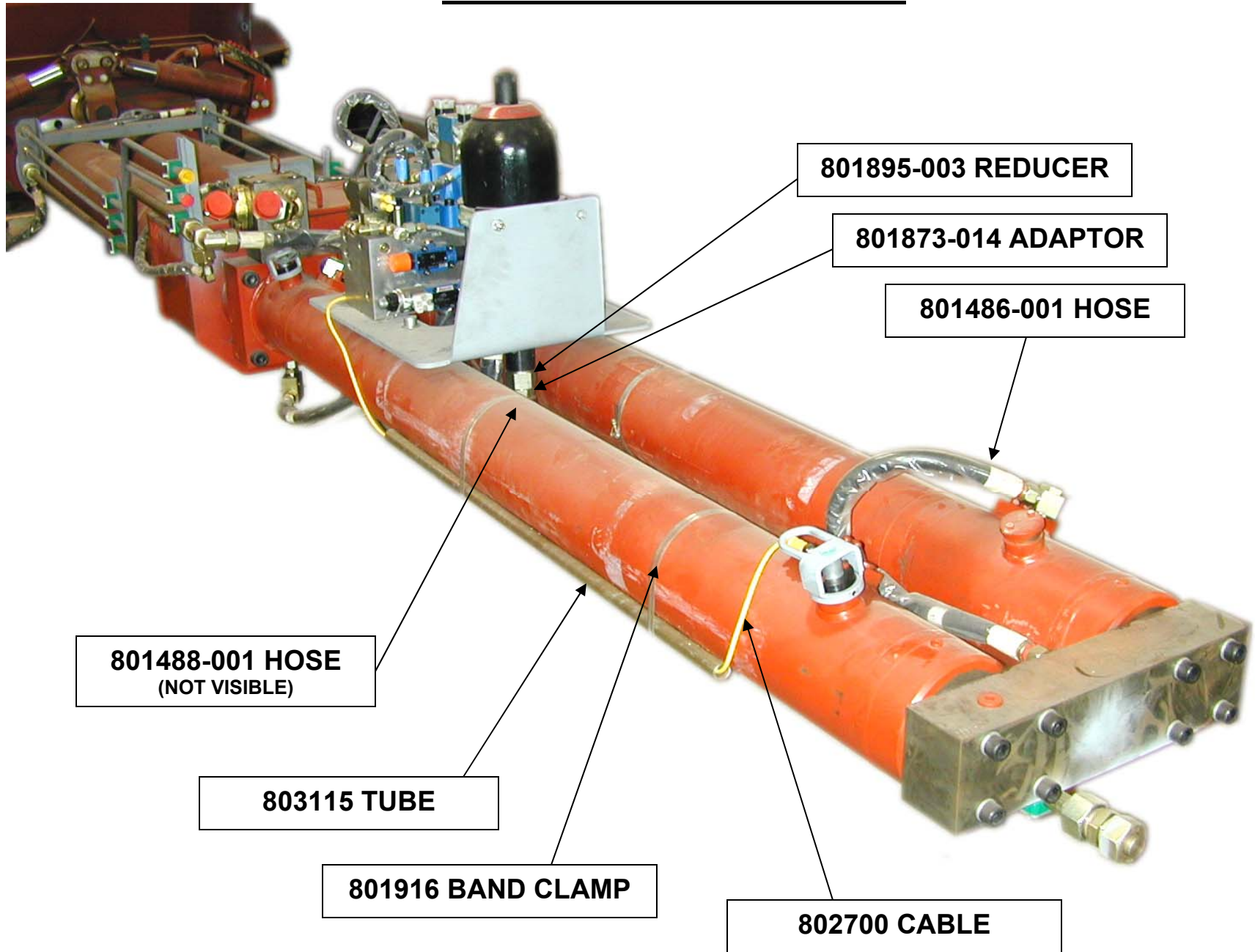

PUMP CELL-CLOSED LOOP-ASSEMBLY PROCEDURES-PG 3 OF 29
REED MODELS – XXT37/XXT42

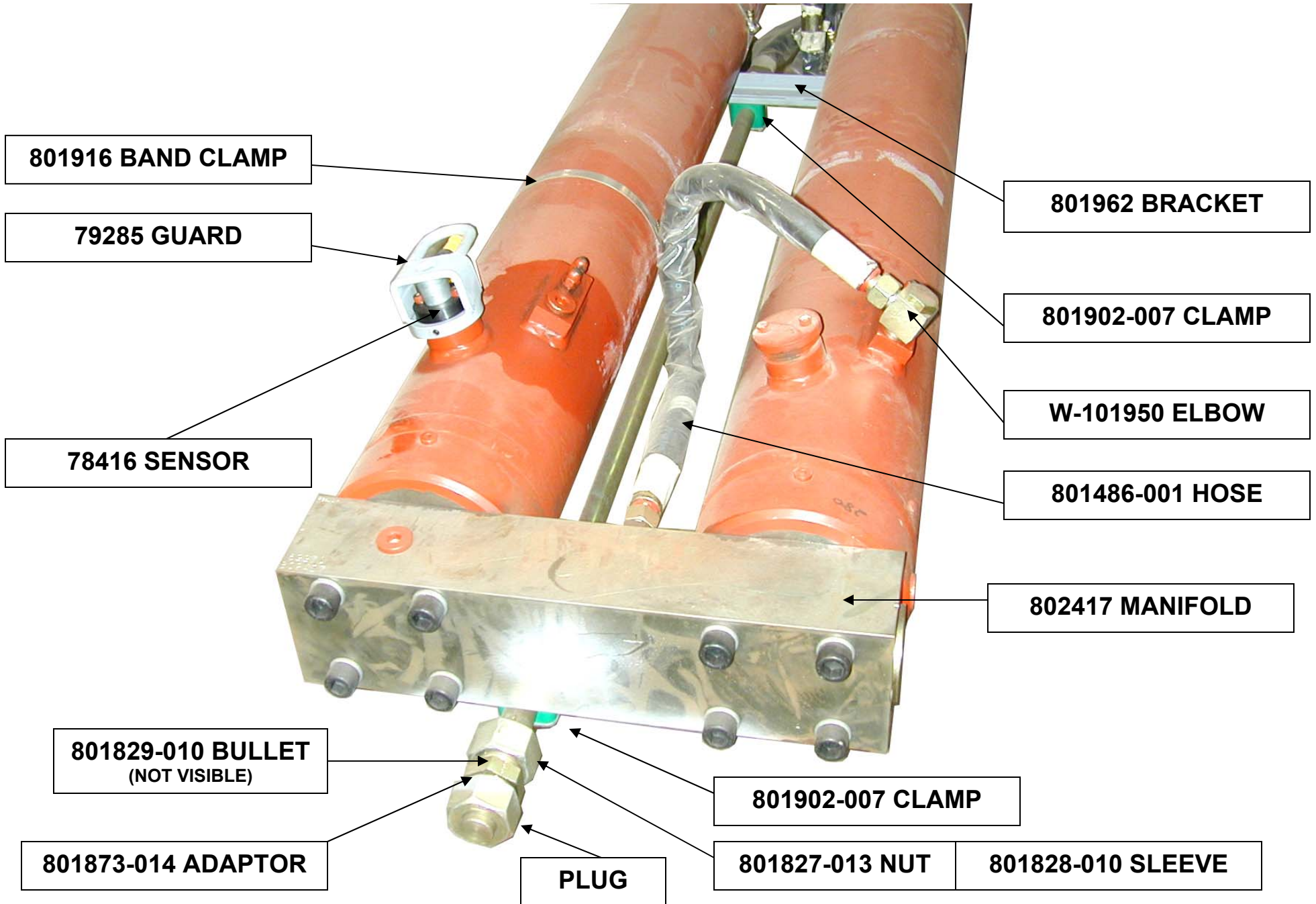

PUMP CELL-CLOSED LOOP-ASSEMBLY PROCEDURES-PG 4 OF 29
REED MODELS – XXT37/XXT42

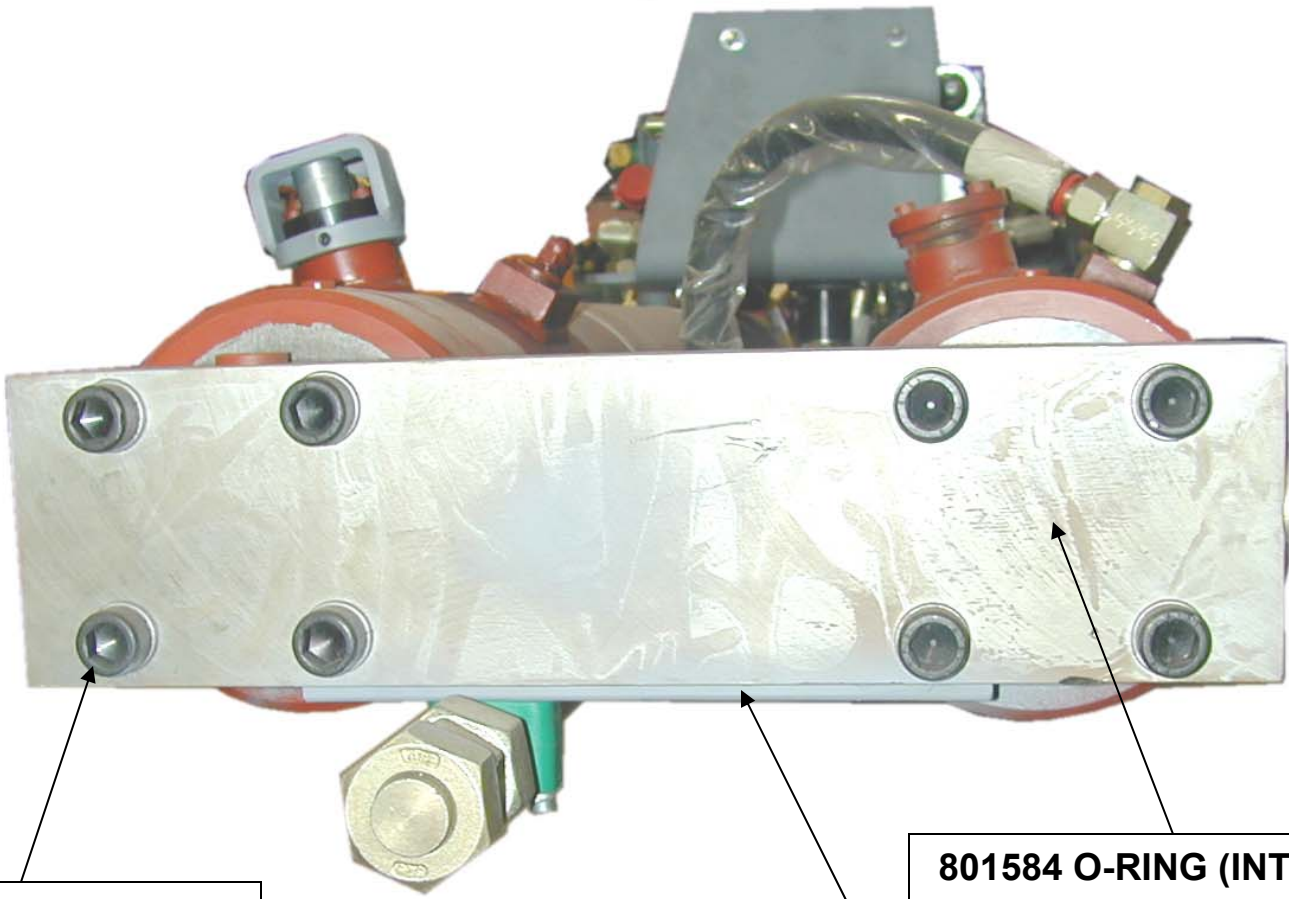

802549 SHCS M16
803117 WASHER-M16

801171-012 C-RAIL

801584 O-RING (INTERNAL)

PUMP CELL-CLOSED LOOP-ASSEMBLY PROCEDURES-PG 5 OF 29
REED MODELS – XXT37/XXT42

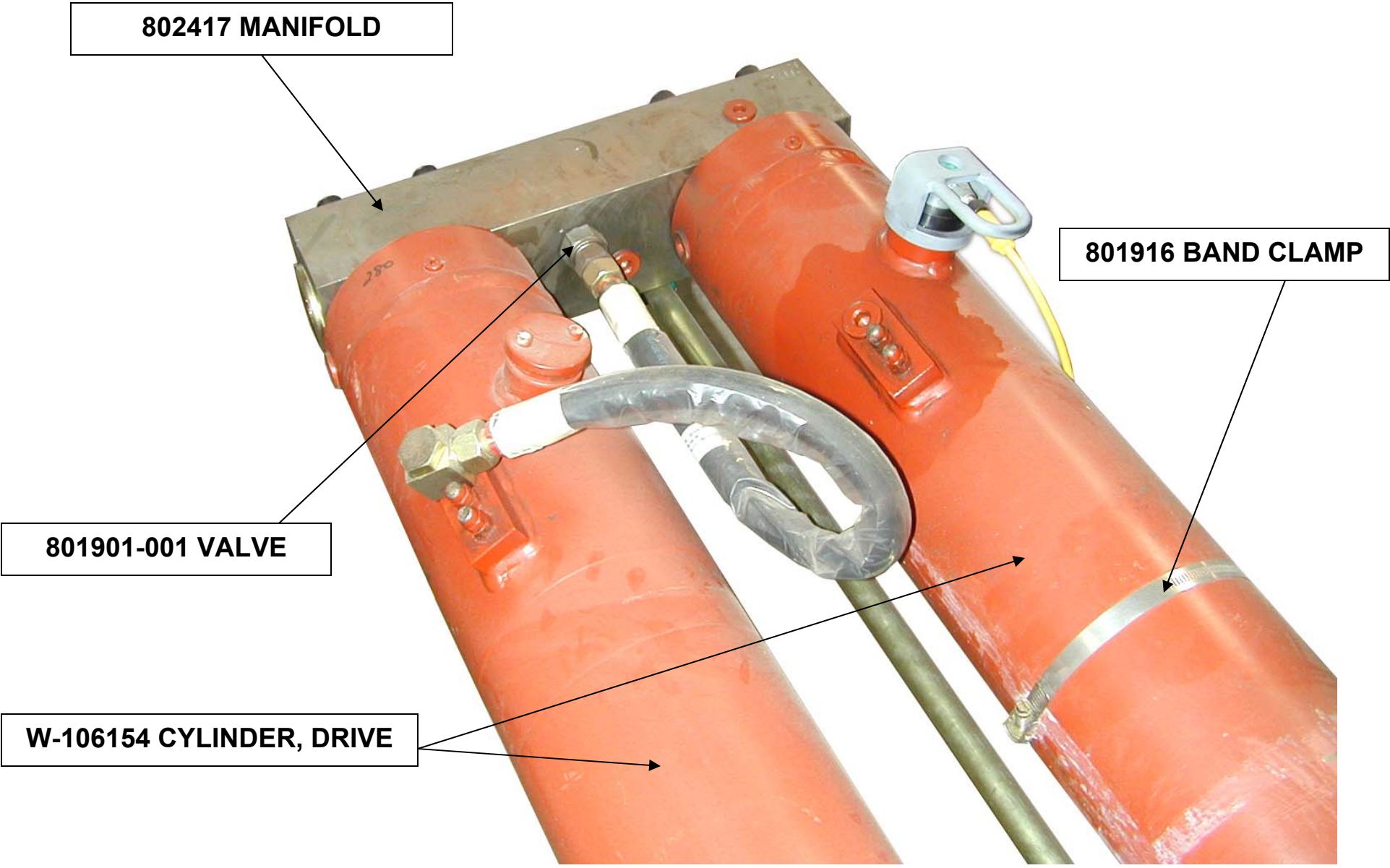

PUMP CELL-CLOSED LOOP-ASSEMBLY PROCEDURES-PG 6 OF 29
REED MODELS - XXT37/XXT42

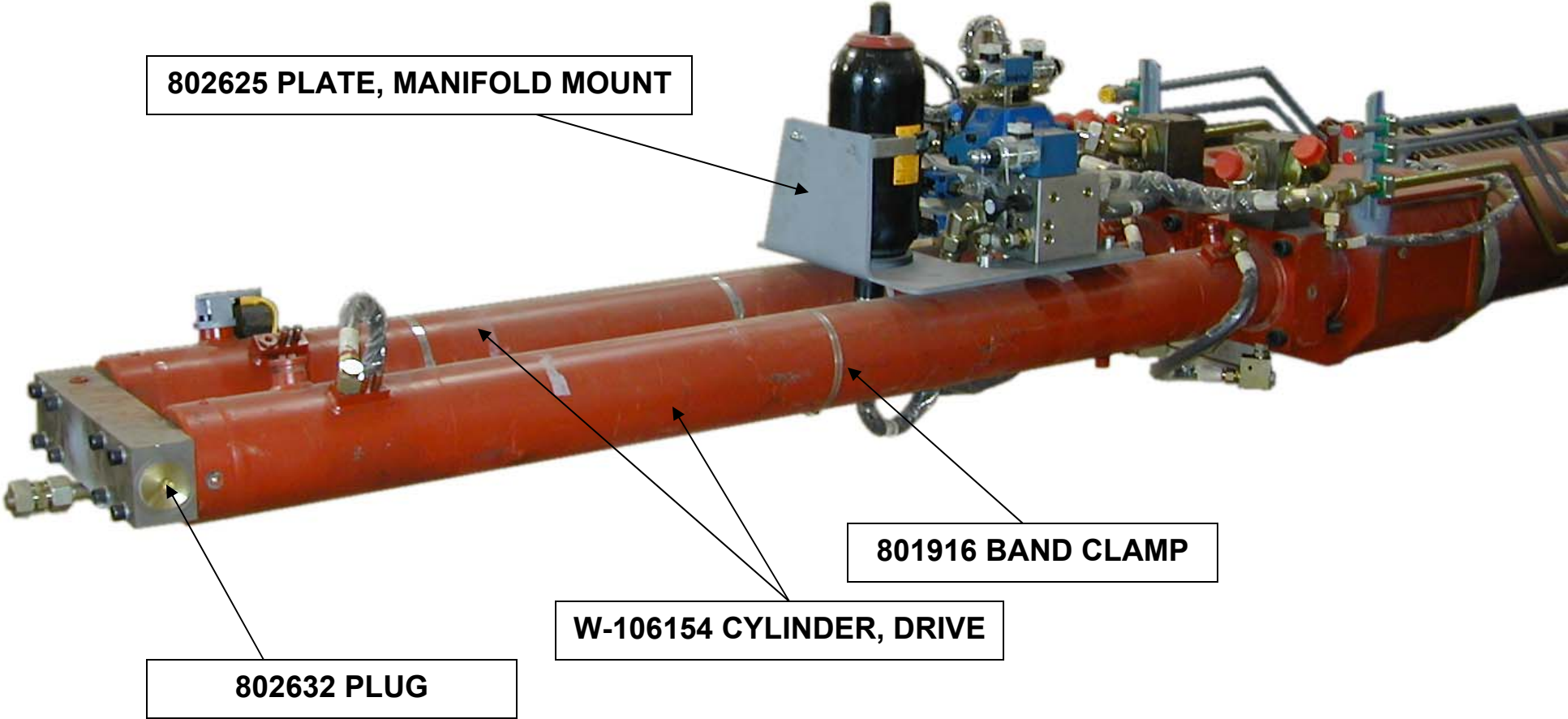

PUMP CELL-CLOSED LOOP-ASSEMBLY PROCEDURES-PG 7 OF 29
REED MODELS – XXT37/XXT42

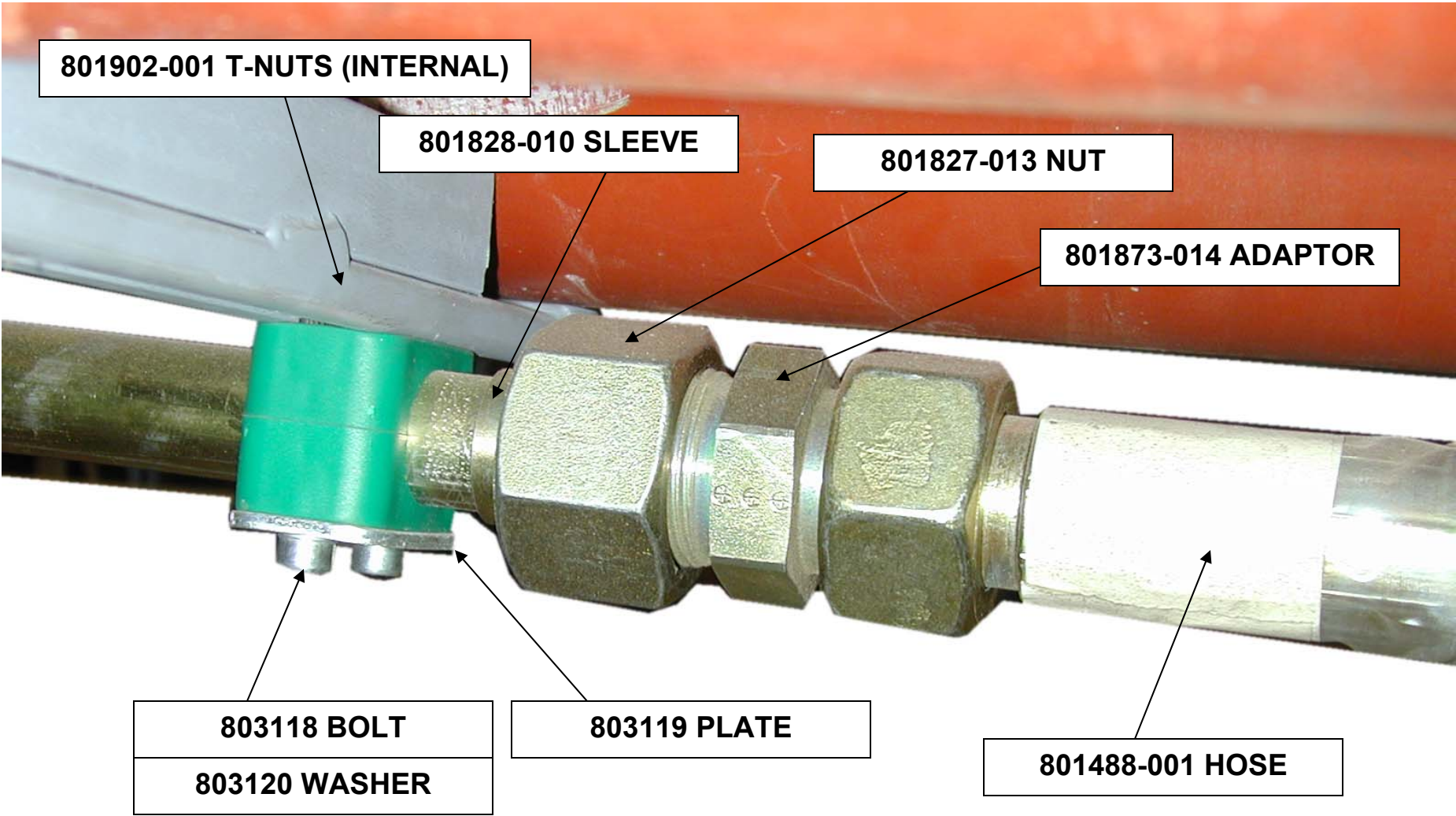

PUMP CELL-CLOSED LOOP-ASSEMBLY PROCEDURES-PG 8 OF 29
REED MODELS – XXT37/XXT42

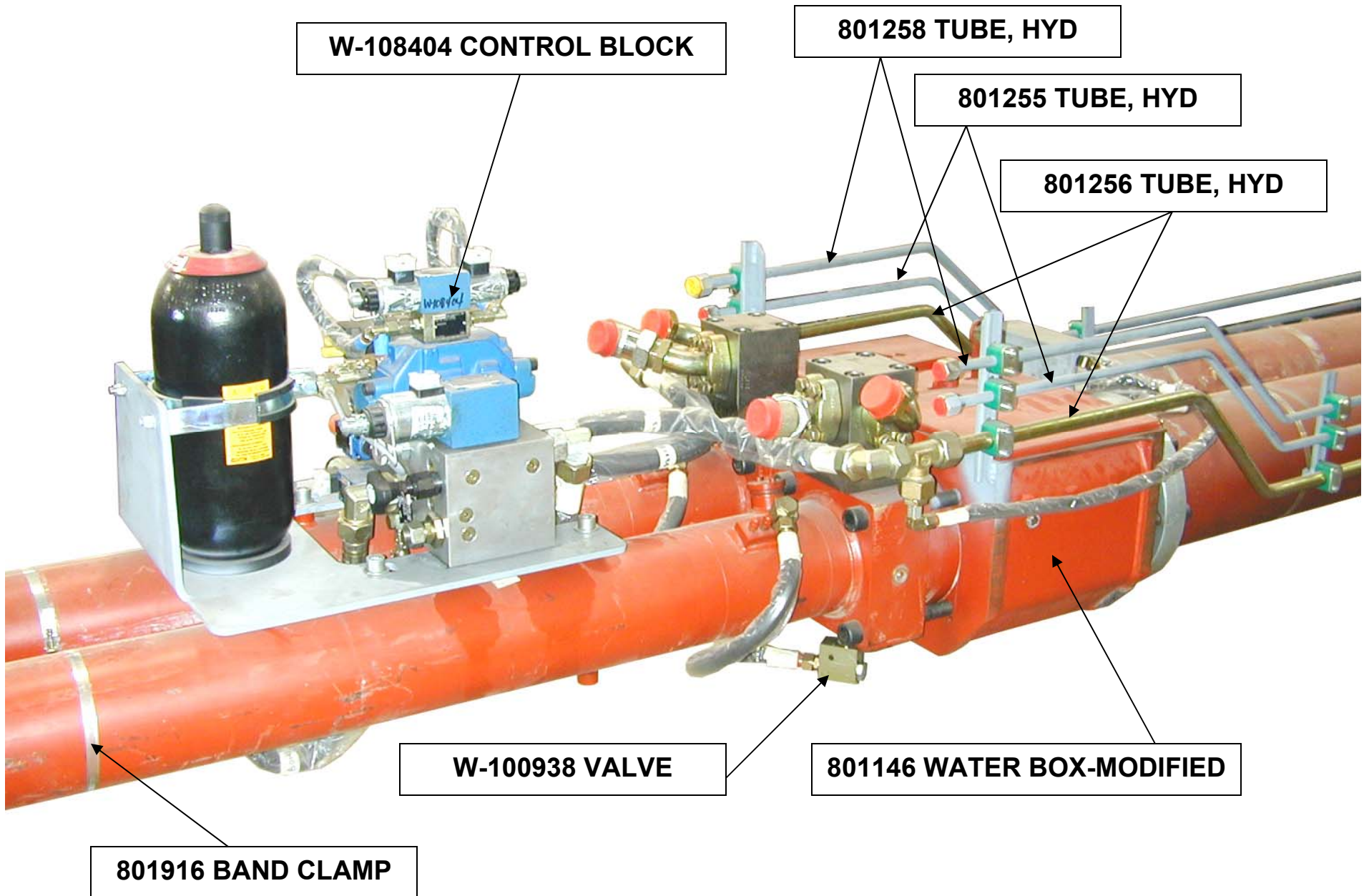

PUMP CELL-CLOSED LOOP-ASSEMBLY PROCEDURES-PG 9 OF 29
REED MODELS – XXT37/XXT42

W-108404 CONTROL BLOCK

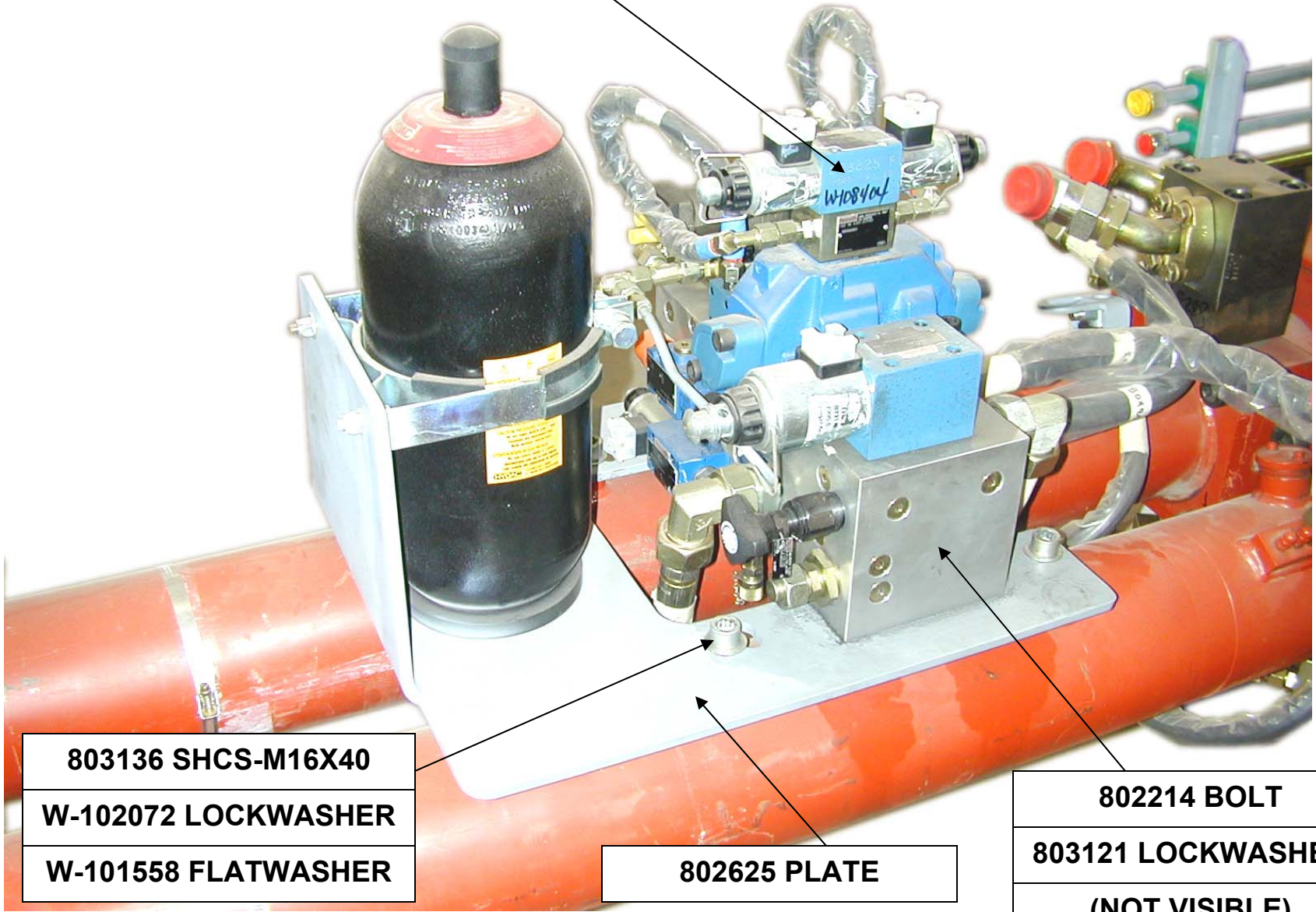

803136 SHCS-M16X40
W-102072 LOCKWASHER
W-101558 FLATWASHER

802625 PLATE

802214 BOLT
803121 LOCKWASHER
(NOT VISIBLE)

PUMP CELL-CLOSED LOOP-ASSEMBLY PROCEDURES-PG 10 OF 29
REED MODELS – XXT37/XXT42

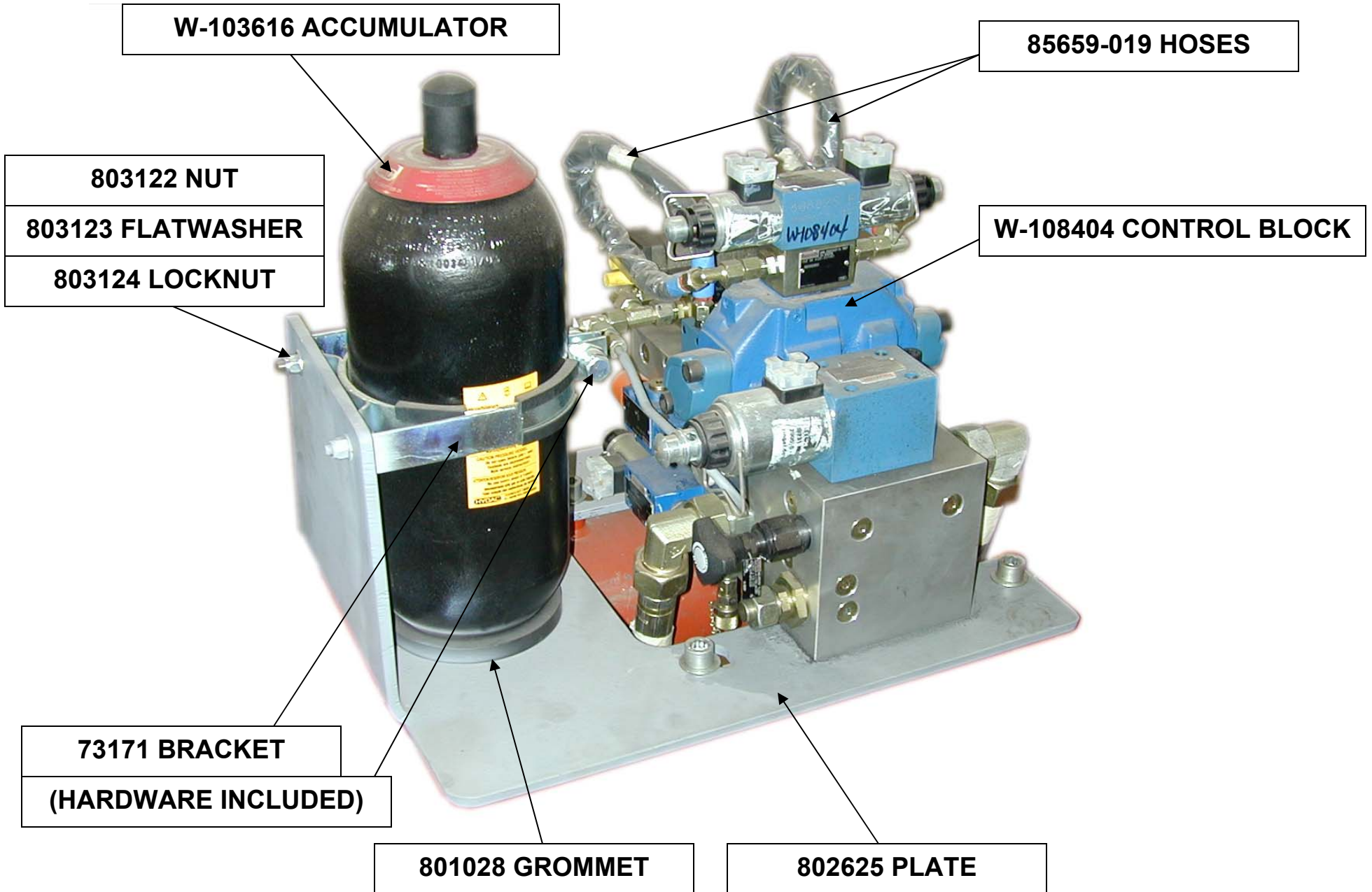

PUMP CELL-CLOSED LOOP-ASSEMBLY PROCEDURES-PG 11 OF 29
REED MODELS – XXT37/XXT42

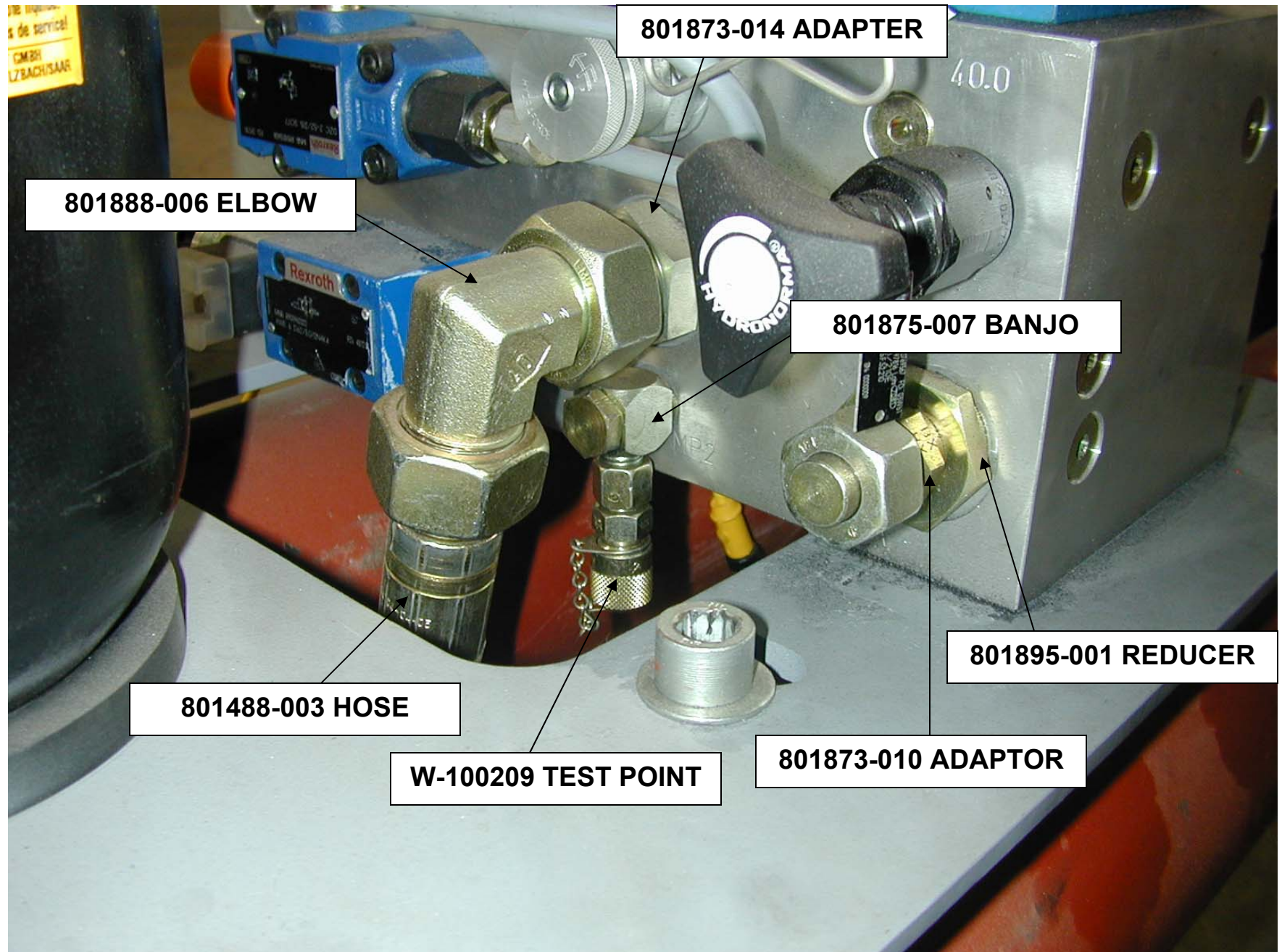

PUMP CELL-CLOSED LOOP-ASSEMBLY PROCEDURES-PG 12 OF 29
REED MODELS – XXT37/XXT42

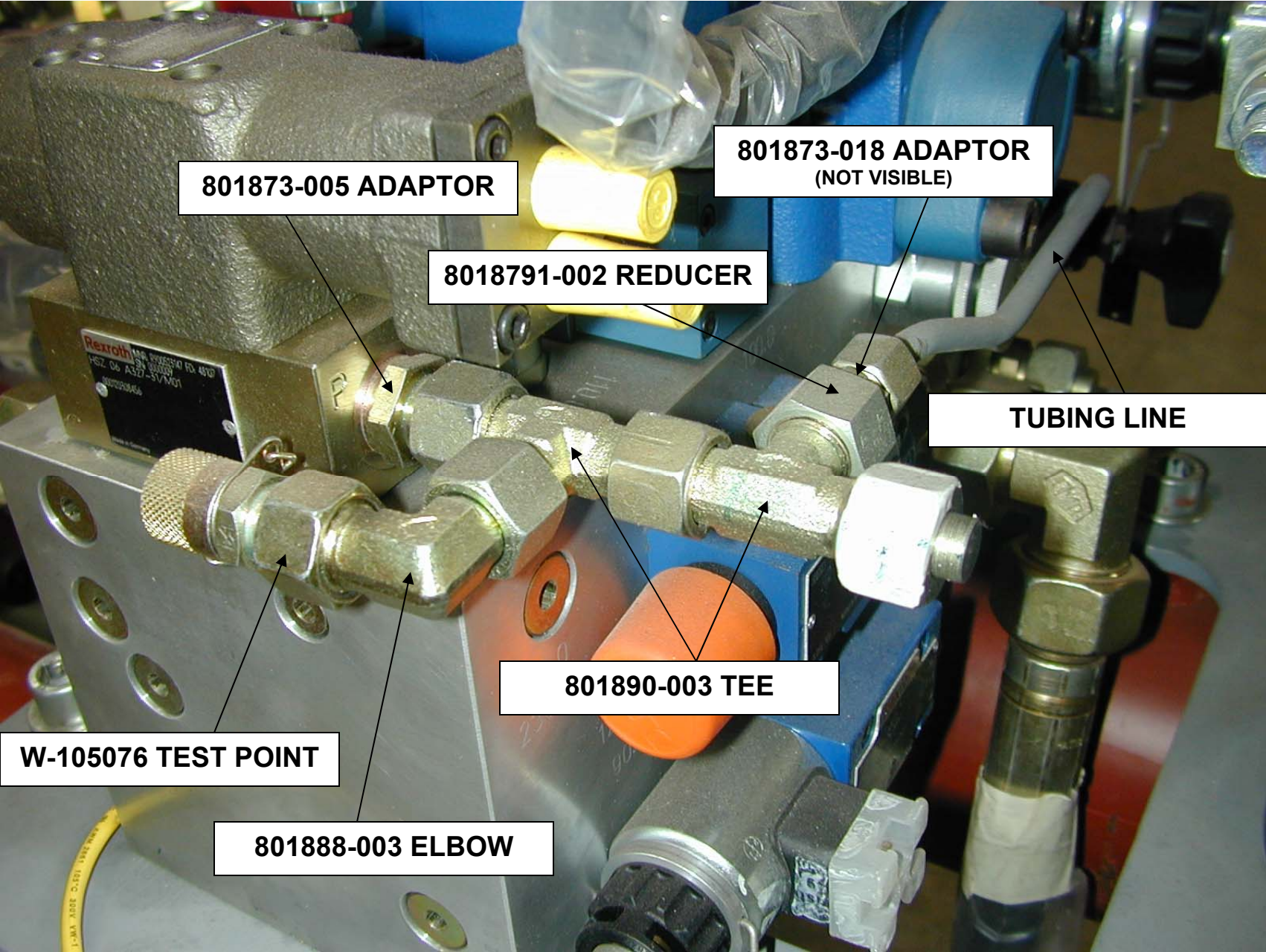

PUMP CELL-CLOSED LOOP-ASSEMBLY PROCEDURES-PG 13 OF 29
REED MODELS – XXT37/XXT42

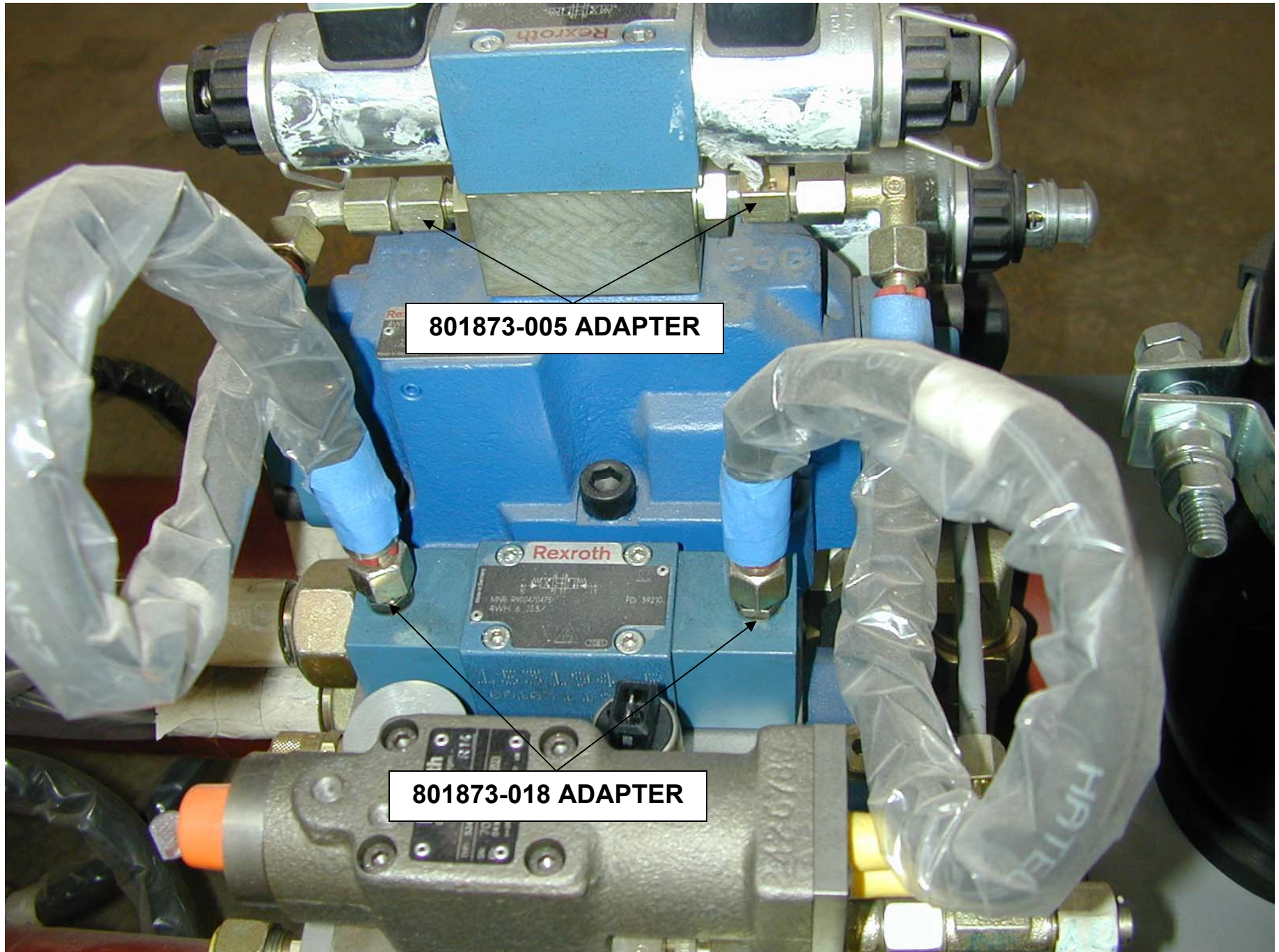

PUMP CELL-CLOSED LOOP-ASSEMBLY PROCEDURES-PG 14 OF 29
REED MODELS – XXT37/XXT42



RIGHTSIDE VIEW

PUMP CELL-CLOSED LOOP-ASSEMBLY PROCEDURES-PG 15 OF 29
REED MODELS – XXT37/XXT42

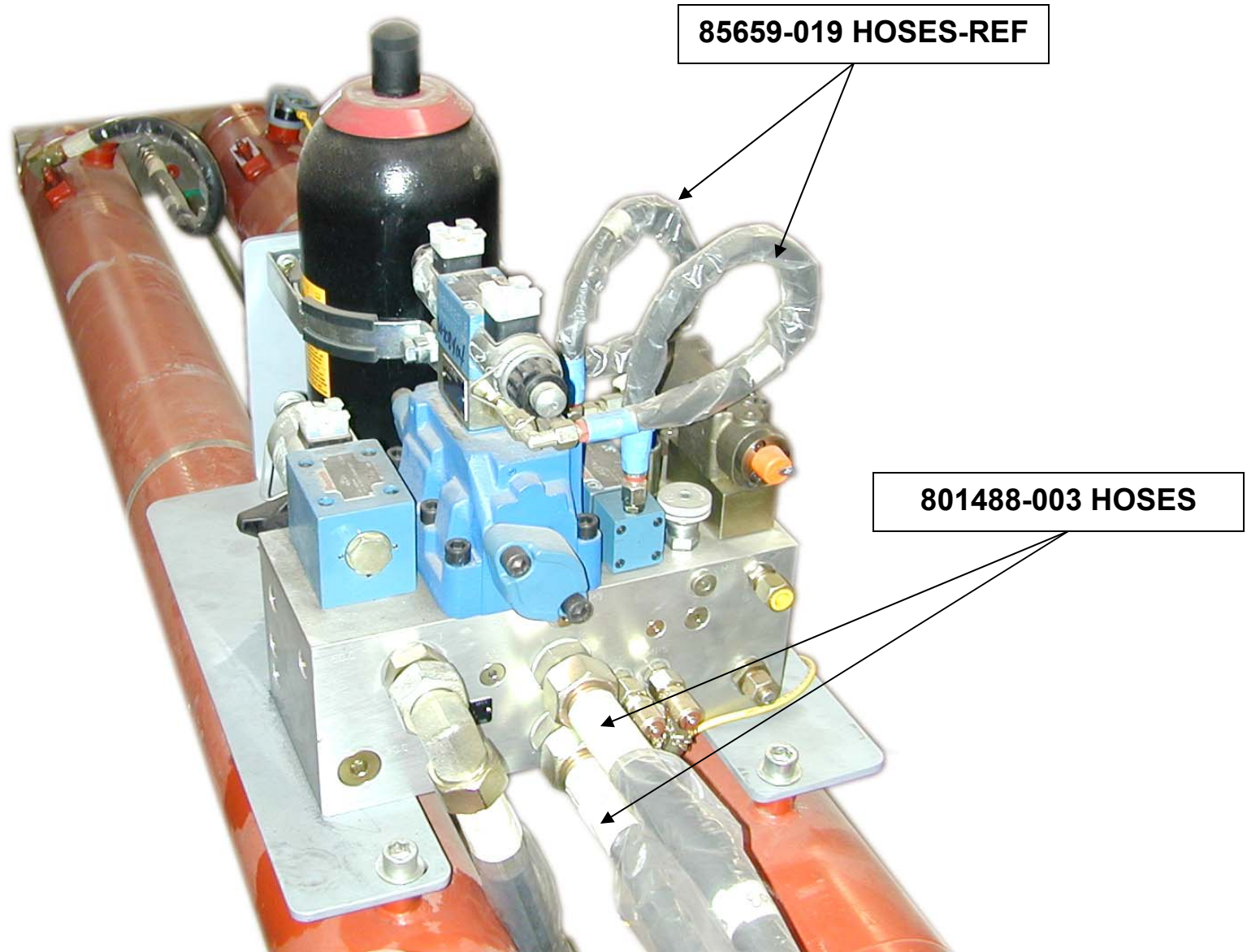

PUMP CELL-CLOSED LOOP-ASSEMBLY PROCEDURES-PG 16 OF 29
REED MODELS – XXT37/XXT42

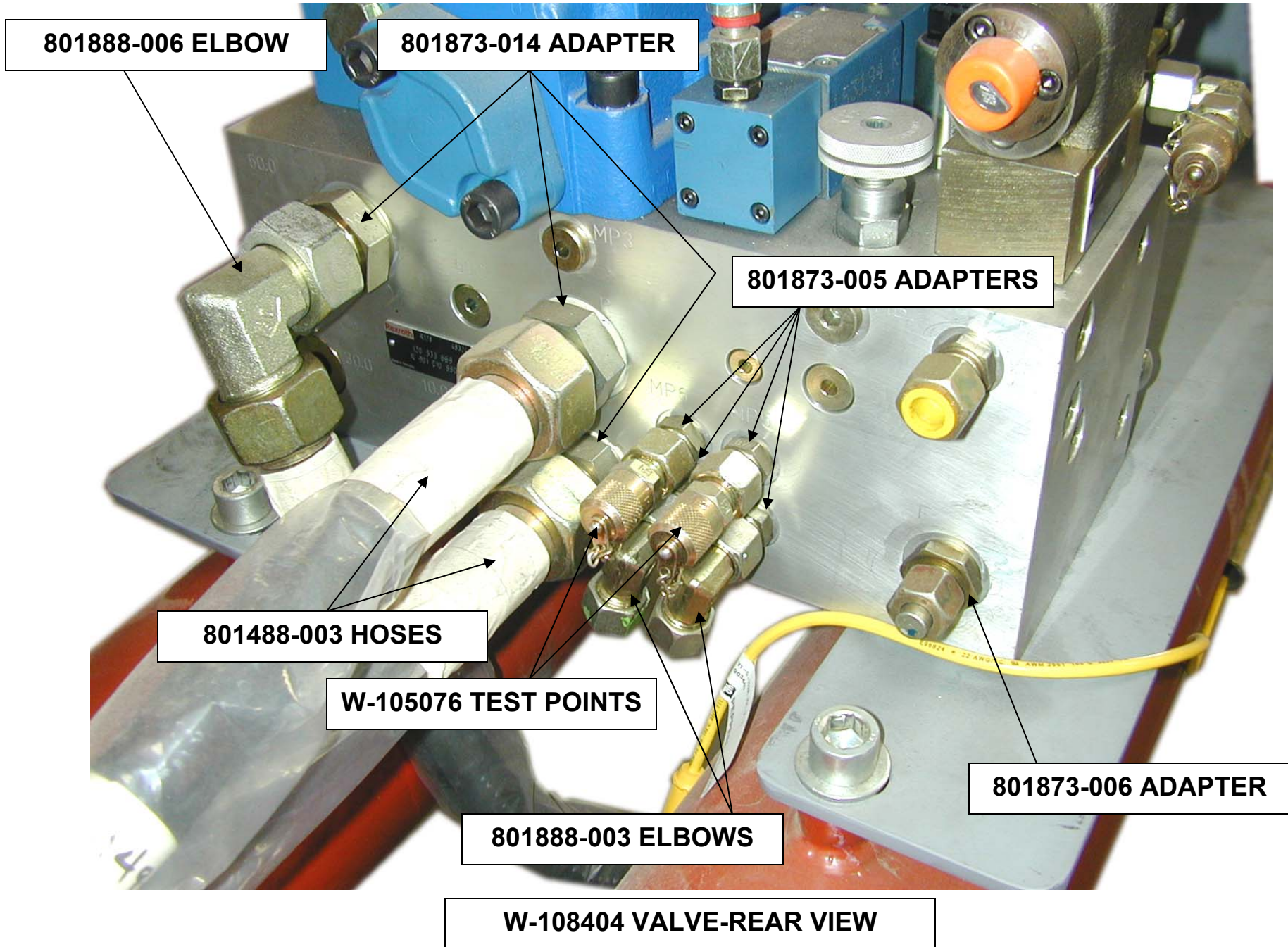

PUMP CELL-CLOSED LOOP-ASSEMBLY PROCEDURES-PG 17 OF 29
REED MODELS – XXT37/XXT42

802416 MANIFOLD
802890 SUB-PLATE
802946 SHCS
803134 WASHERS

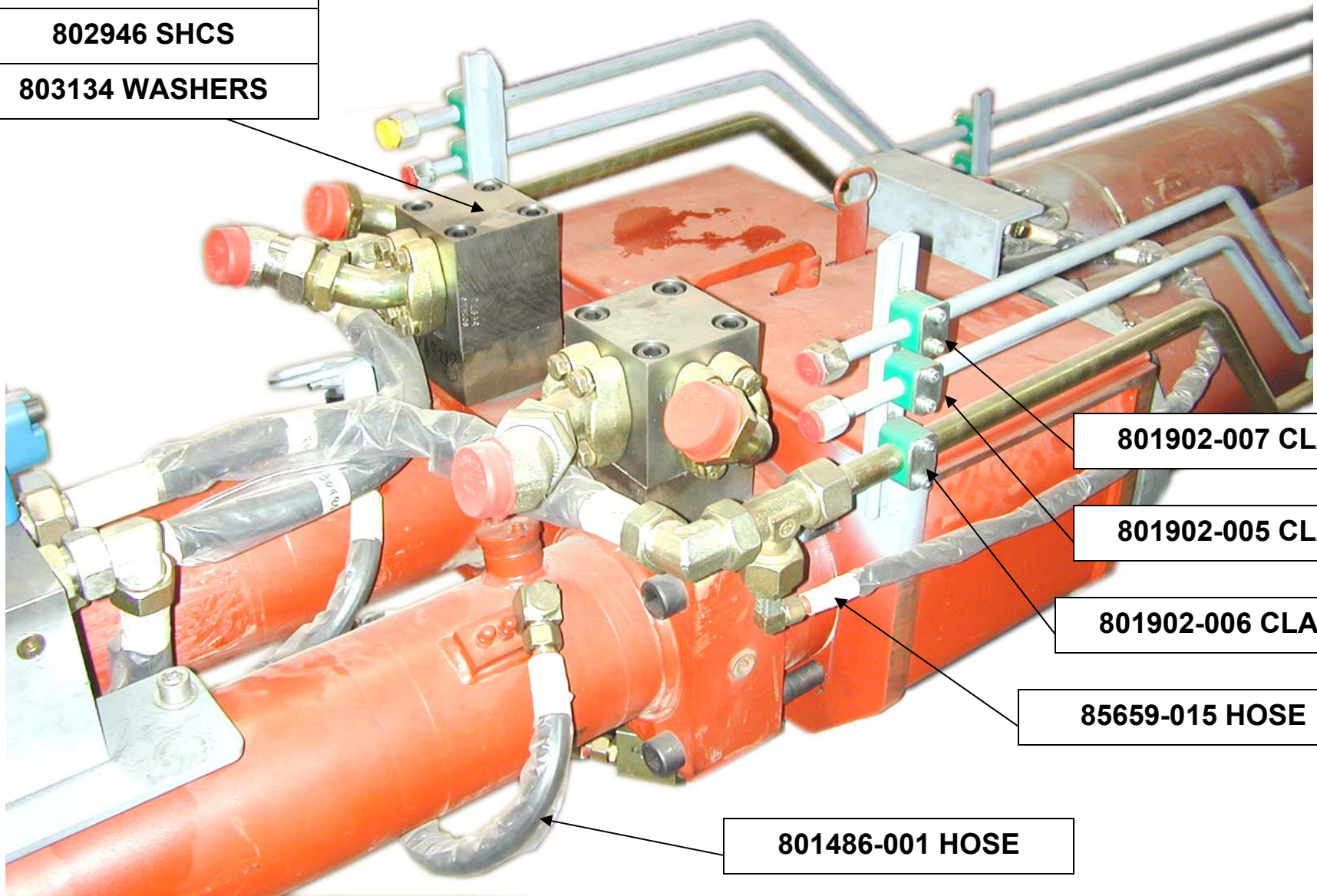

801902-007 CLAMP

801902-005 CLAMP

801902-006 CLAMP

85659-015 HOSE

801486-001 HOSE

PUMP CELL-CLOSED LOOP-ASSEMBLY PROCEDURES-PG 18 OF 29
REED MODELS – XXT37/XXT42

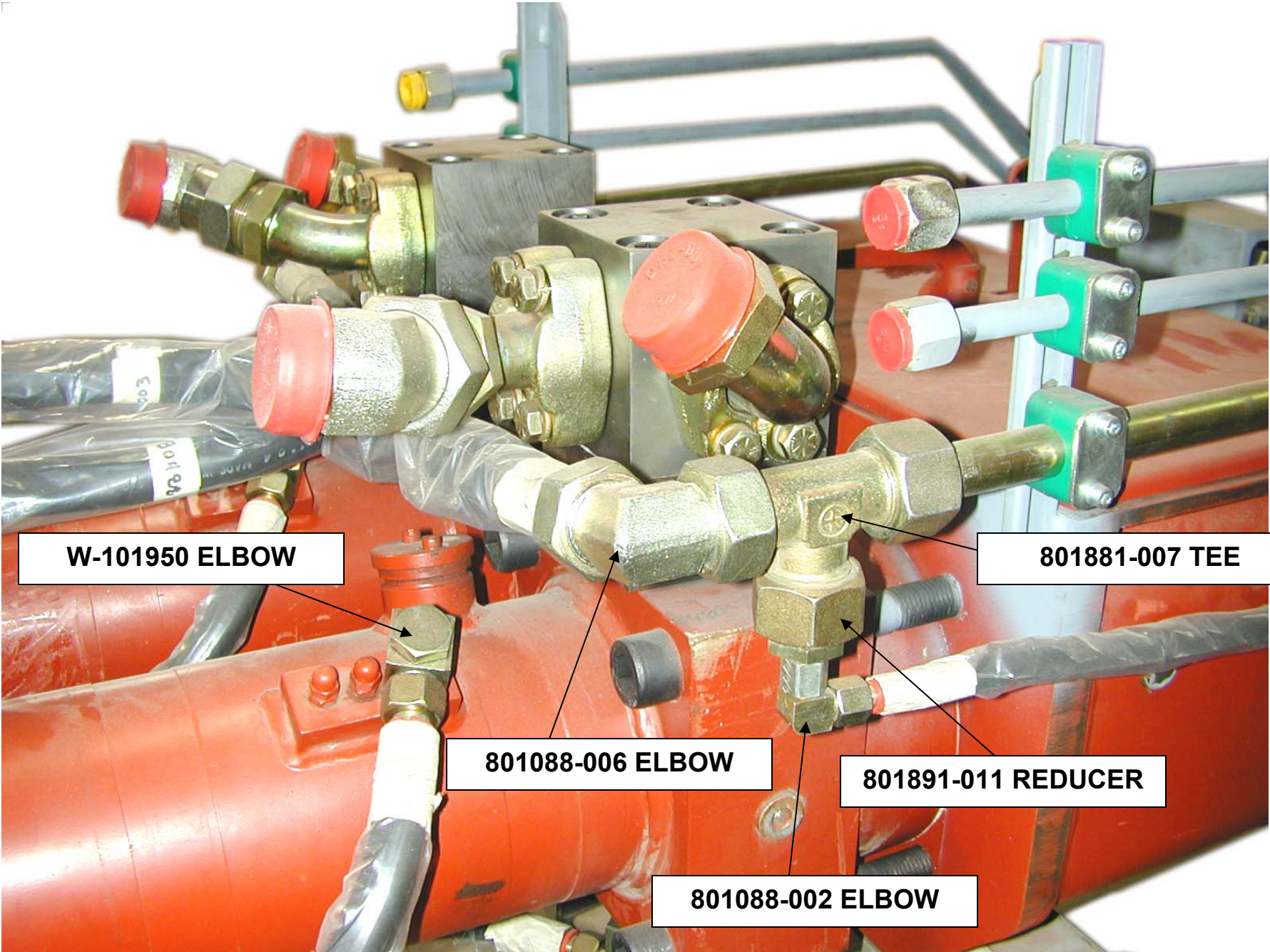

W-101950 ELBOW

801881-007 TEE

801088-006 ELBOW

801891-011 REDUCER

801088-002 ELBOW

PUMP CELL-CLOSED LOOP-ASSEMBLY PROCEDURES-PG 19 OF 29
REED MODELS – XXT37/XXT42

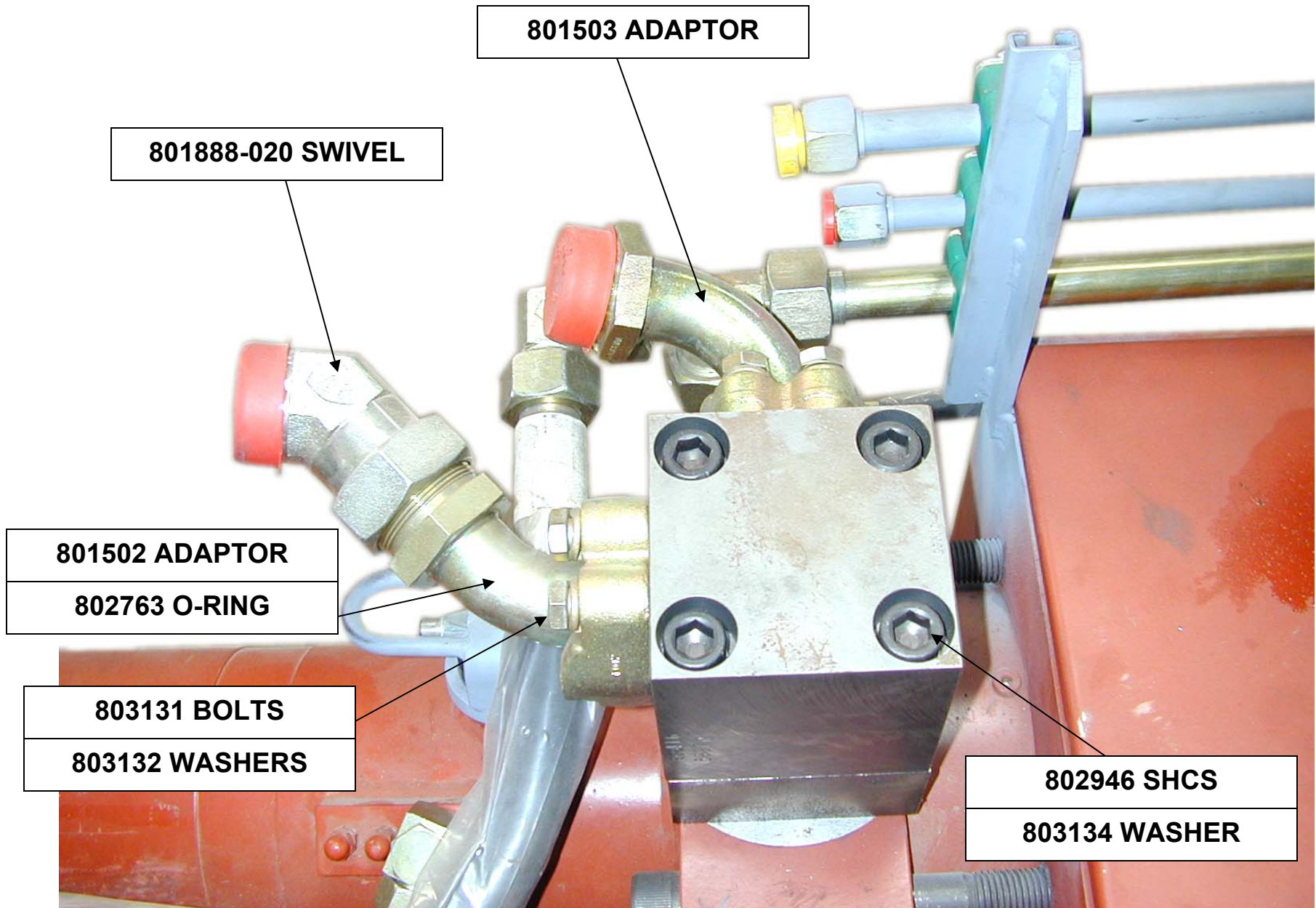

PUMP CELL-CLOSED LOOP-ASSEMBLY PROCEDURES-PG 20 OF 29
REED MODELS – XXT37/XXT42

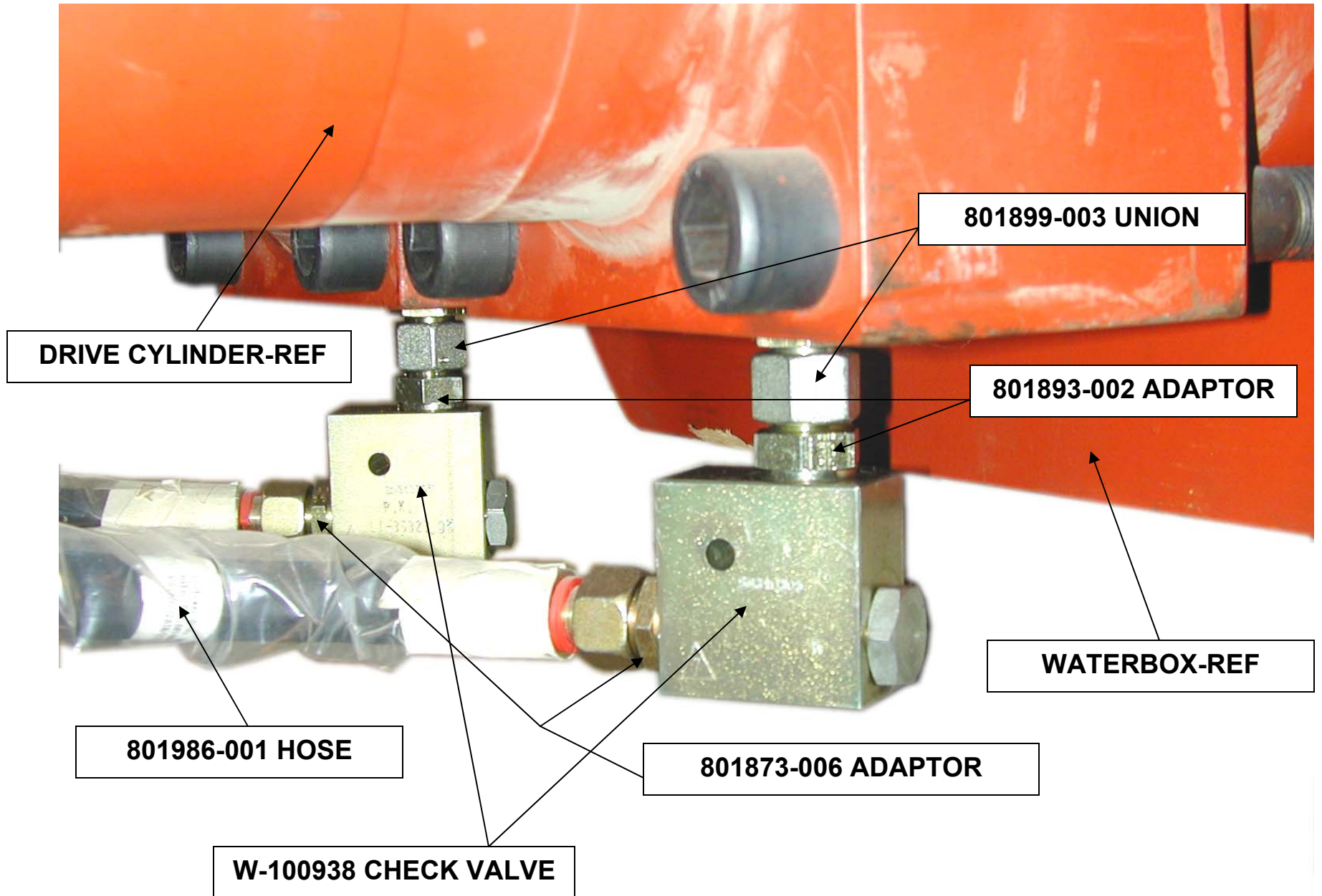

PUMP CELL-CLOSED LOOP-ASSEMBLY PROCEDURES-PG 21 OF 29
REED MODELS – XXT37/XXT42

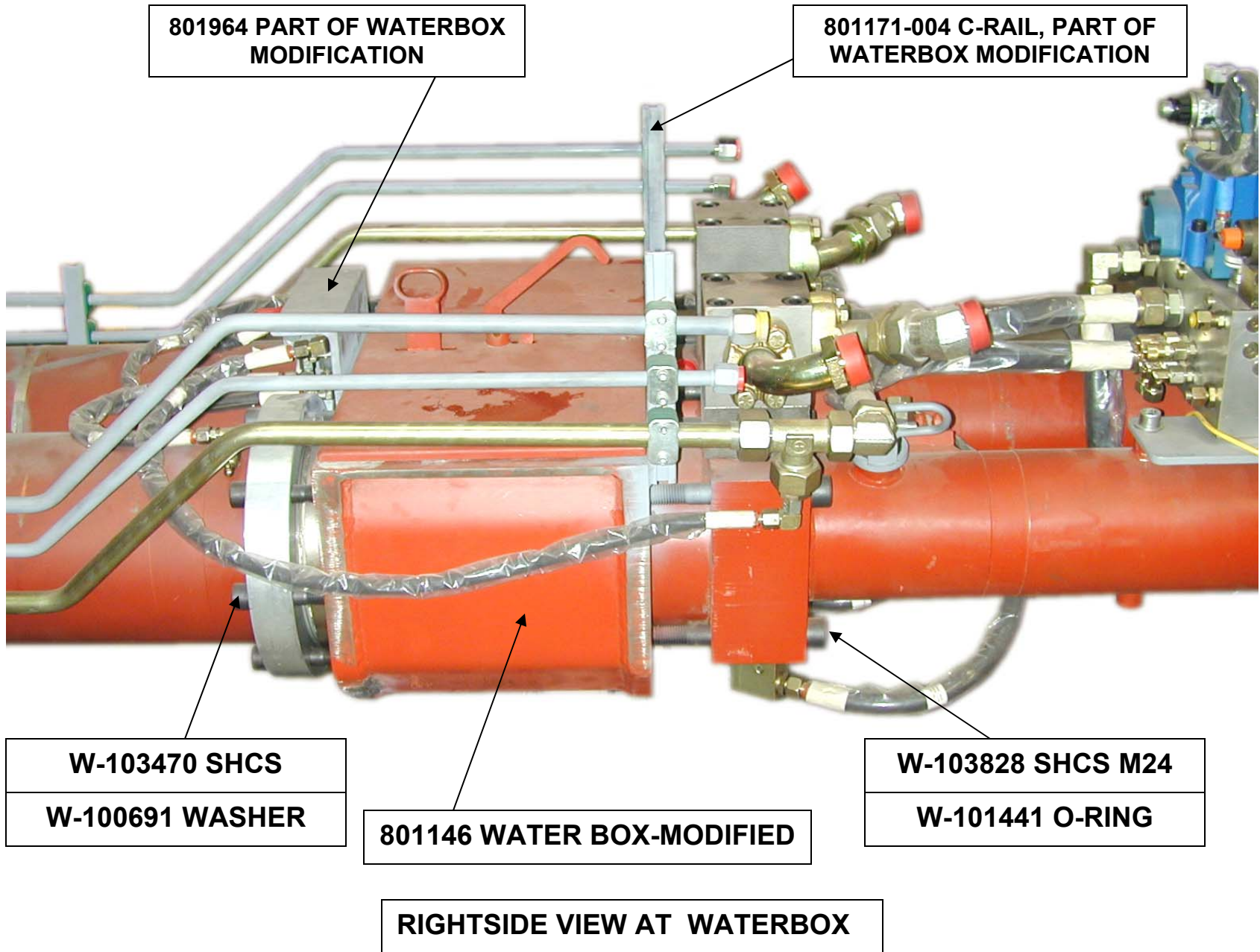

PUMP CELL-CLOSED LOOP-ASSEMBLY PROCEDURES-PG 22 OF 29
REED MODELS – XXT37/XXT42

**801964 BRACKET
(PART OF WATER BOX MOD.)**

B-123012 RING
**W-102868 O-RING
(NOT VISIBLE)**

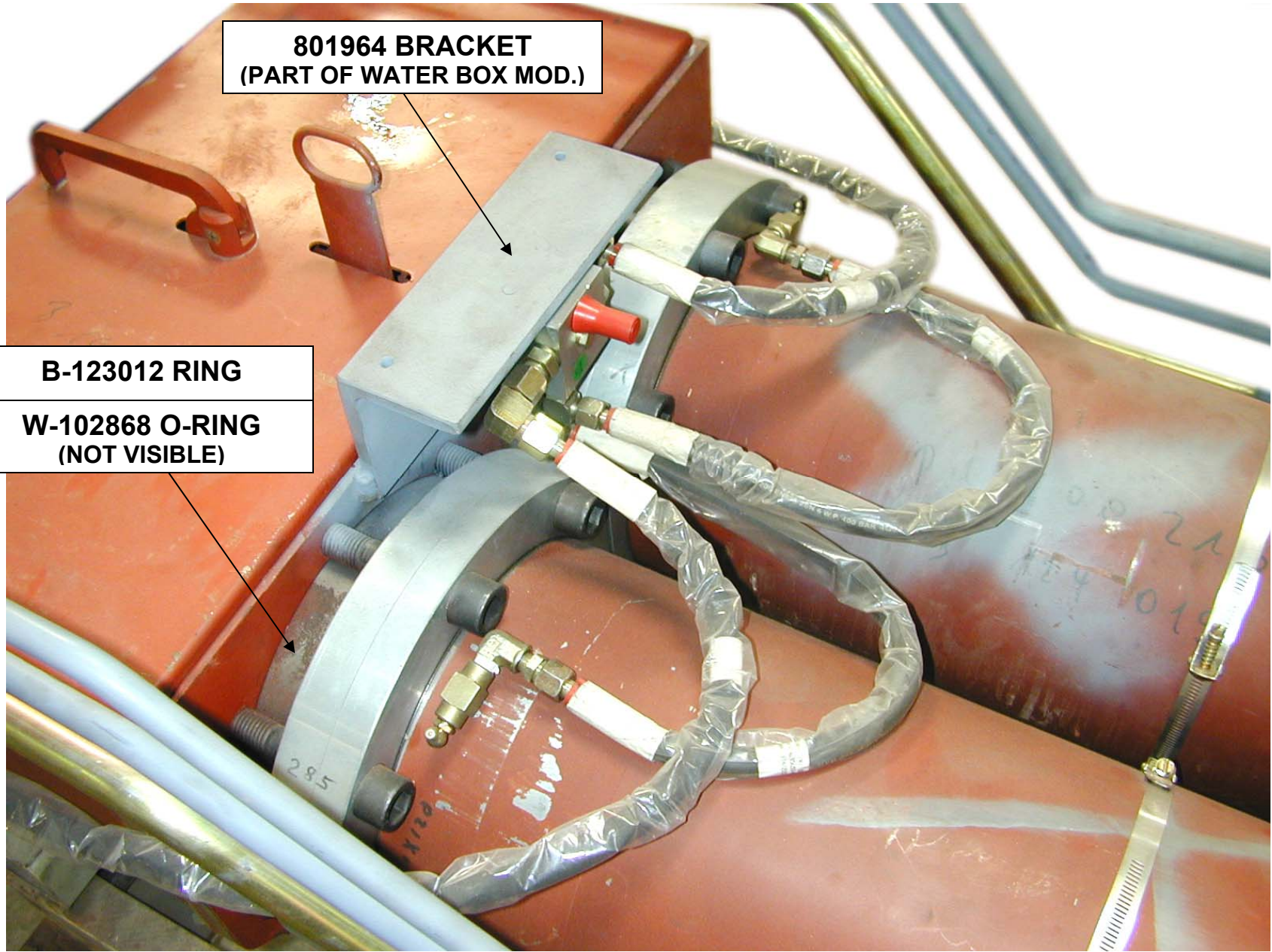

PUMP CELL-CLOSED LOOP-ASSEMBLY PROCEDURES-PG 23 OF 29
REED MODELS – XXT37/XXT42



PUMP CELL-CLOSED LOOP-ASSEMBLY PROCEDURES-PG 24 OF 29
REED MODELS – XXT37/XXT42

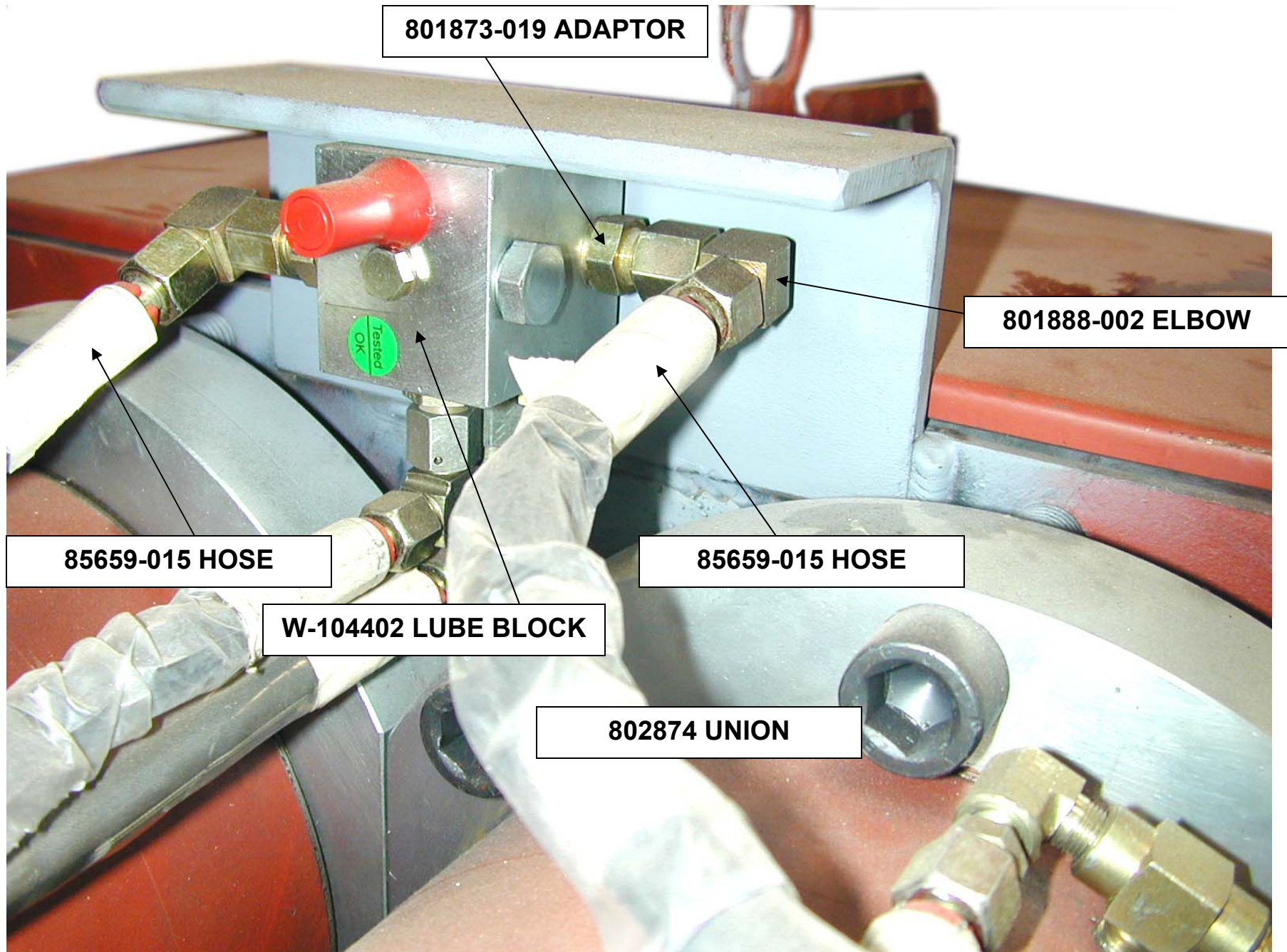

801873-019 ADAPTOR

801888-002 ELBOW

85659-015 HOSE

85659-015 HOSE

W-104402 LUBE BLOCK

802874 UNION

PUMP CELL-CLOSED LOOP-ASSEMBLY PROCEDURES-PG 25 OF 29
REED MODELS – XXT37/XXT42

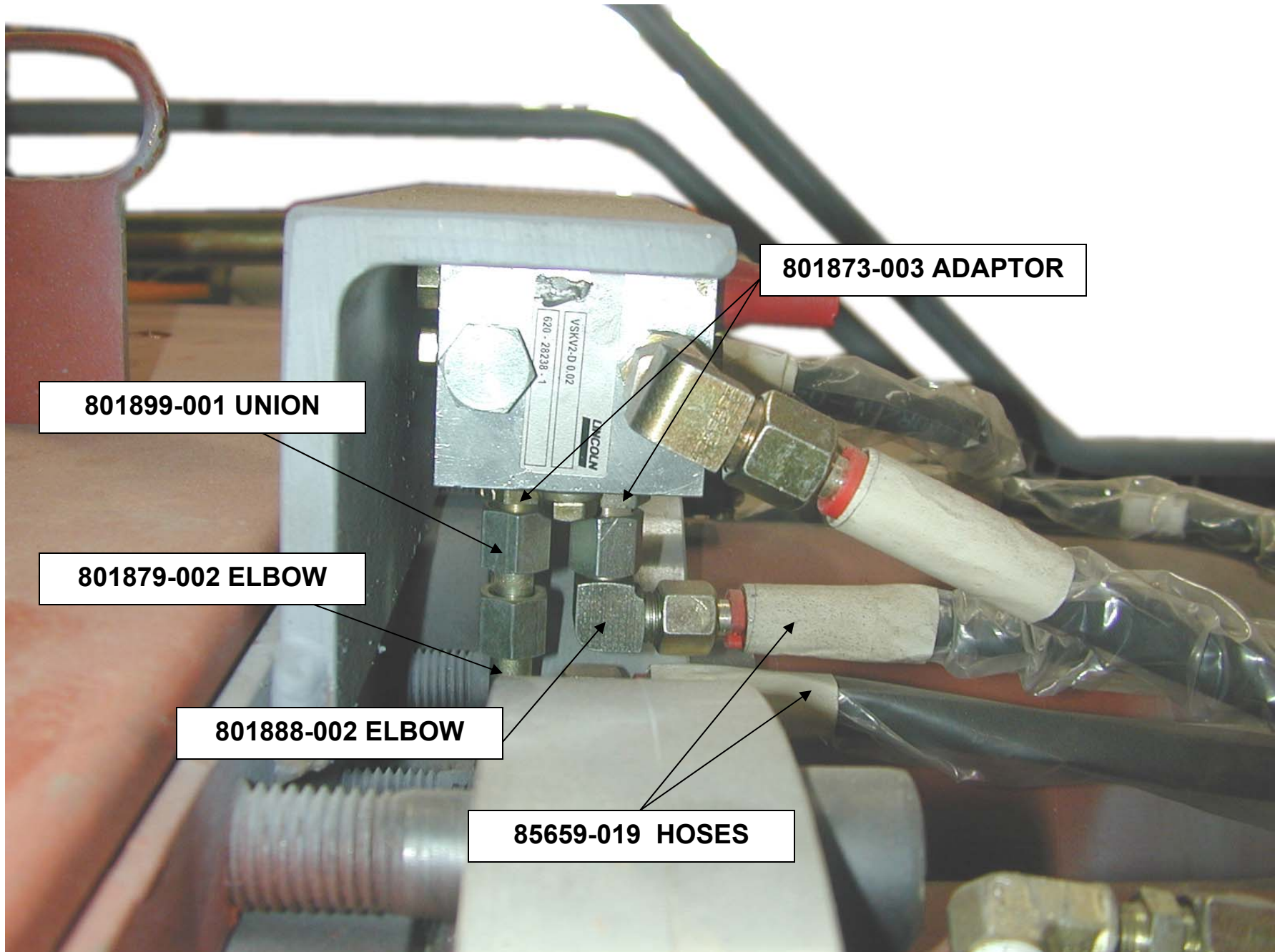

801899-001 UNION

801879-002 ELBOW

801888-002 ELBOW

85659-019 HOSES

801873-003 ADAPTOR

PUMP CELL-CLOSED LOOP-ASSEMBLY PROCEDURES-PG 26 OF 29
REED MODELS – XXT37/XXT42

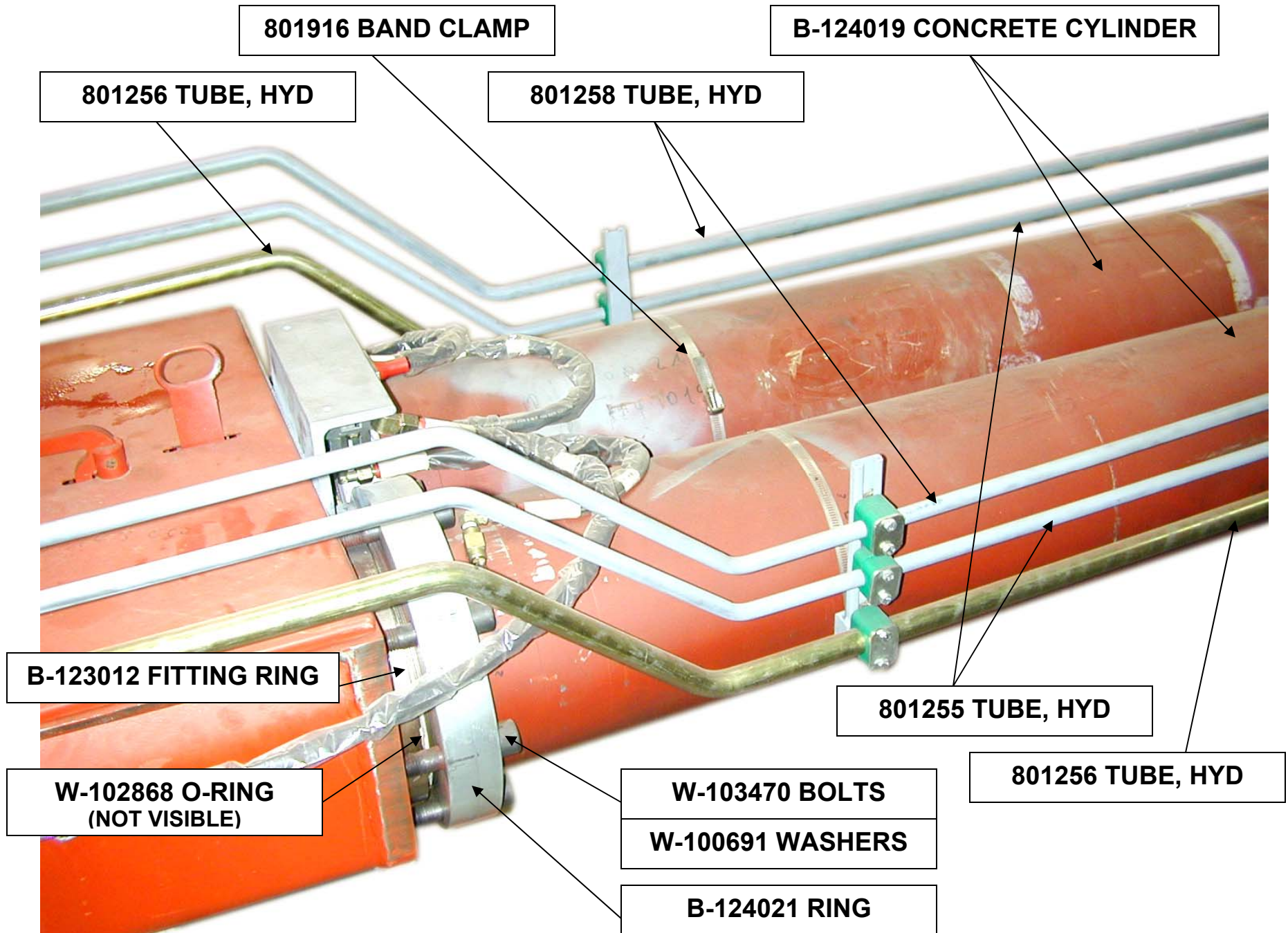

PUMP CELL-CLOSED LOOP-ASSEMBLY PROCEDURES-PG 27 OF 29
REED MODELS – XXT37/XXT42

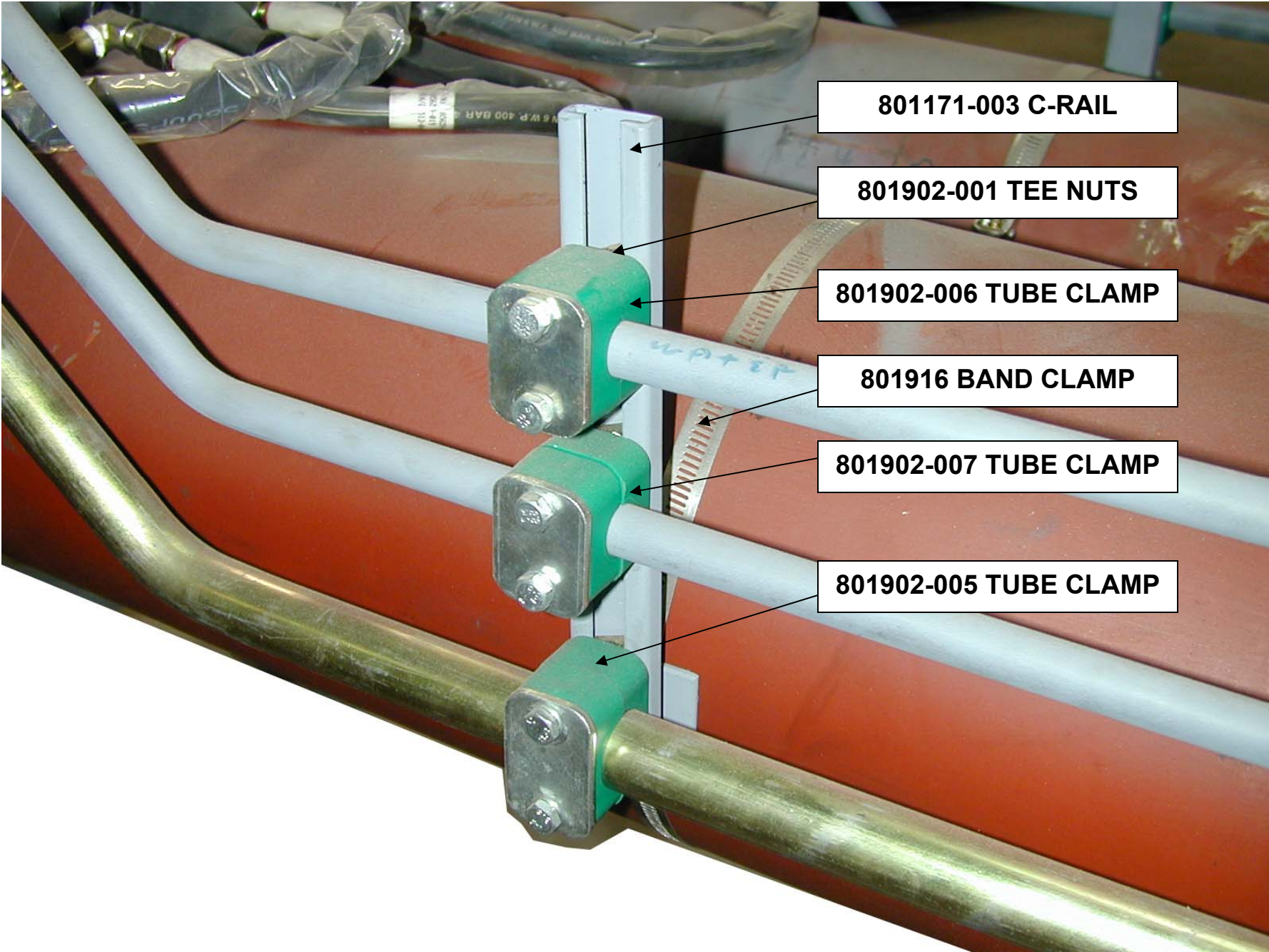

PUMP CELL-CLOSED LOOP-ASSEMBLY PROCEDURES-PG 28 OF 29
REED MODELS – XXT37/XXT42

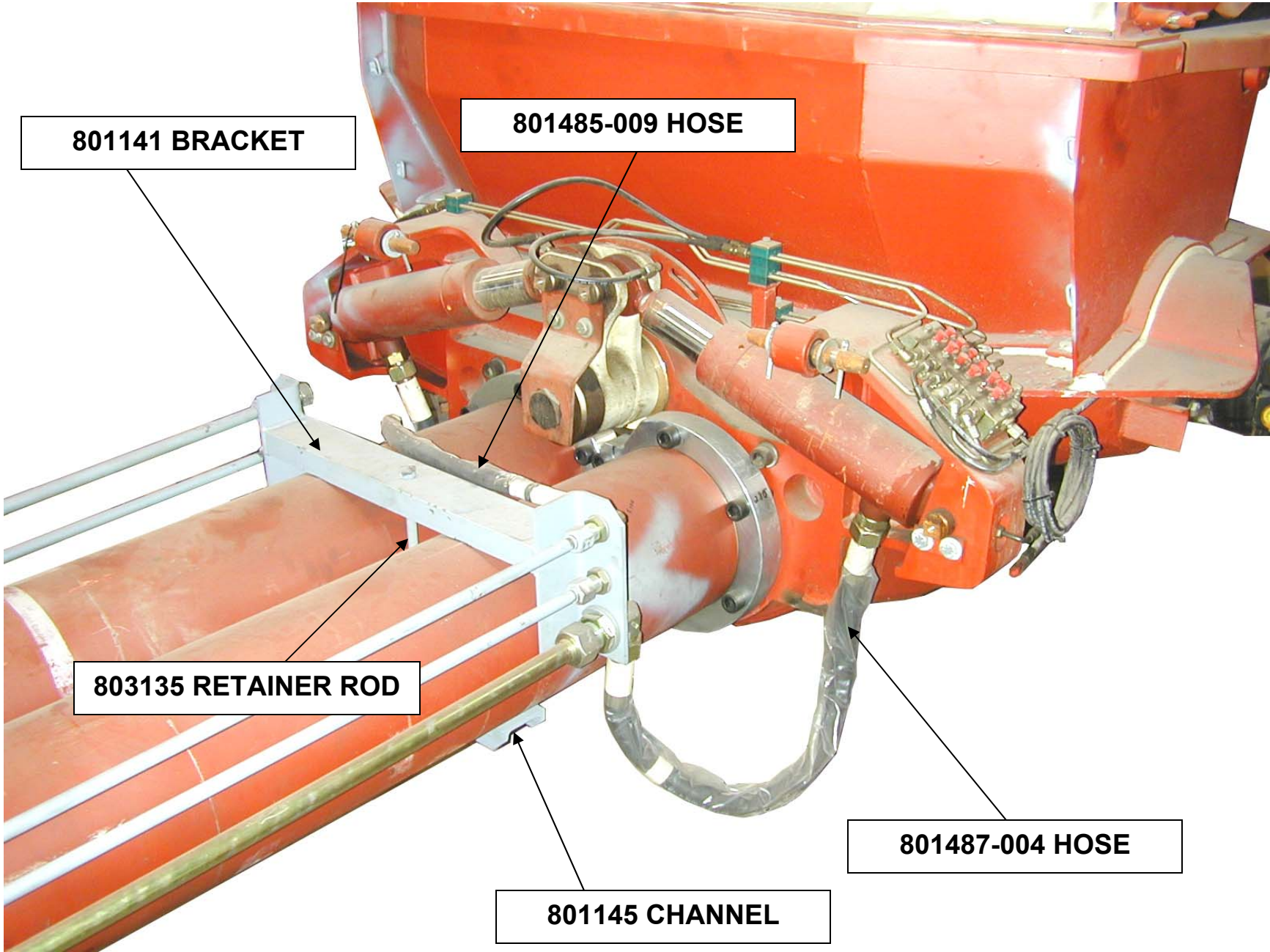

PUMP CELL-CLOSED LOOP-ASSEMBLY PROCEDURES-PG 29 OF 29
REED MODELS – XXT37/XXT42

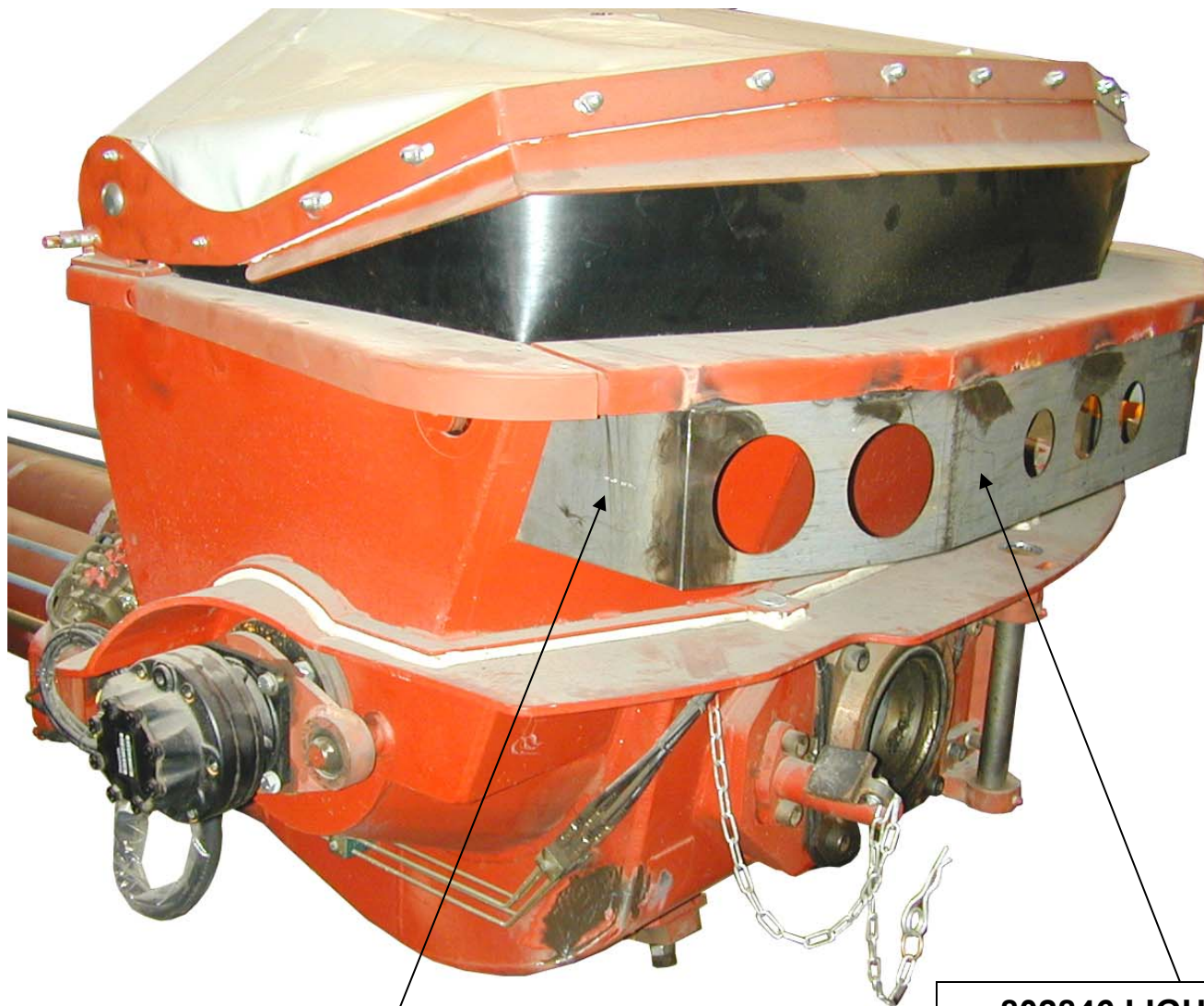

802847 SIDE PLATE, LIGHT HOLDER

802846 LIGHT HOLDER

BASE END MANIFOLD TO CONTROL BLOCK AREA

BOM Rank	Part Number	Part Description	Quantity
1	W-106154	CYLINDER,DRIVE-140/80X2000	2
1	W-101441	O-RING 129,2X5,7	8
1	W-103828	BOLT, SHCS, M24X200 DIN 912 10.9	8
1	W-101950	ELBOW, BANJO, THROTTLEFREE	3
1	802700	CABLE, PROXIMITY SWITCH, FEM RIGHT	1
1	78416	SENSOR,PROX.SEN P&F,CYL MOUNT,NPN	2
1	79285	GUARD, PROX SWITCH GUARD	2
1	803115	TUBE, 801826-008 CUT TO 60"	1
1	801916	CLAMP, BAND CLAMP	3
1	801902-007	CLAMP, 25MM TUBE CLAMP SET	4
2	801902-001	NUT, TEE NUT, TUBE CLAMP	4
1	802417	MANIFOLD, CYLINDER, BASE END	1
1	801584	O-RING, FLANGE, 32FLOR	2
1	802549	BOLT, SHCS-M16X120 DIN 912-12.9	8
1	803117	WASHER, M16	8
1	802632	PLUG, SAE 32, RECESSED	1
1	801901-001	VALVE,CHECK VA.-15LX1/2BSPP-PORT	1
1	803116	TUBE, 801826-008 CUT TO 52"	1
2	801828-010	SLEEVE, TUBE SLEEVE, METRIC, 25S	2
2	801829-010	BULLET, TUBE BULLET, METRIC, 25S	2
2	801827-013	NUT, TUBE NUT, METRIC, 25S	2
1	801873-014	ADAPTOR - 25S X 1" BSPP	2
1	801962	BRACKET - TUBE SUPPORT	1
1	801171-012	C-RAIL 6.00 LONG	1

CONTROL BLOCK AREA

BOM Rank	Part Number	Part Description	Quantity
1	W-103616	ACCUMULATOR, 6 LITER, S-TUBE	1
1	73171	ACCUMULATOR BKT.W/CLOSING HARDWARE	1
1	801028	GROMMET, ACCUMULATOR	1
1	803122	BOLT, 7/16"X1 3/4" BOLT	2
1	803123	WASHER, 7/16" WASHER	2
1	803124	NUT, 7/16" LOCK NUT	2
1	802625	PLATE, MANIFOLD MOUNT	1
1	803136	BOLT, SCHS M16X40	4
1	W-101558	WASHER, DIN 6916 17	4
1	W-102072	WASHER, LOCK WASHER, M16 DIN 127	4
1	W-108404	CONTROL BLOCK CLOSE LOOP 12VREXROT	1
1	85659-019	HOSE, 4M2T-8FDLX-8FDLX-20.00	2

1	801488-003	HOSE, 12G6K-25FDHX-25FDHX-24.00	3
1	801488-001	HOSE, 12G6K-25FDHX-25FDHX-36.00	1
1	801895-003	REDUCER - 1 1/4 BSPP X 1 BSPP	1
1	801873-014	ADAPTOR - 25S X 1" BSPP	4
1	801873-018	ADAPTOR - 08L X 1/8 BSPP	4
1	801873-005	ADAPTOR - 12L X 3/8 BSPP	9
1	801890-003	SWIVEL RUN TEE - 12L	2
1	801891-002	TUBE REDUCER - 12L X 08L	1
1	W-105076	FITTING, GAUGE FITTING - L12	1
1	801888-003	SWIVEL ELBOW - 12L	4
1	801888-006	SWIVEL ELBOW - 25S	2
1	801873-006	ADAPTOR - 12L X 1/2 BSPP	1
1	801895-001	REDUCER - 1 BSPP X 1/2 BSPP	1
1	801873-010	ADAPTOR - 18L X 1/2 BSPP	1
1	801873-003	ADAPTOR - 08L X 1/4 BSPP	1
1	801875-007	BANJO ELBOW -8L X 1/4 BSPP	1
1	W-100209	GAUGE FITTING - L8	1
1	UPDATE	tube-UPDATE DESCRIPTION	1
1	802214	BOLT, M8X25	4
1	803121	WASHER, M8 LOCK WASHER	4

WATERBOX AREA

BOM Rank	Part Number	Part Description	Quantity
1	W-100938	VALVE, CHECK VALVE, CYL MAKEUP	2
1	801893-002	SWIVEL ADAPTOR - 12L X 1/4 BSPP	2
1	801899-003	SWIVEL UNION - 15L	2
1	801146	WATERBOX MODIFICATION	1
2	801964	BRACKET, LUBE VALVE	1
2	801148	GUSSET, TUBE BRACKET	1
2	801171-004	C-RAIL - 10.00 LONG	2
1	802416	MANIFOLD, CYLINDER, ROD END	2
1	802890	MANIFOLD, SUB PLATE, ROD END	2
1	802946	BOLT, M16X180	8
1	803134	WASHER, M16	8
1	801503	ADAPTOR-90L-20FLH X 38S(M)	2
1	801888-020	SWIVEL 45 DEG - 38S	6
1	801502	ADAPTOR-45L-20FLH X 38S(M)	2
1	802763	O-RING #222, BUNA 90 SHORE	2
1	801584	O-RING, FLANGE, 32FLOR	2
1	803131	BOLT, 1/2" X 2" BOLTS	16
1	803132	WASHER, 1/2" LOCK WASHERS	16
1	801888-006	SWIVEL ELBOW - 25S	2
1	801881-007	TUBE TEE - 25S	2
1	801891-011	TUBE REDUCER - 25S X 08S	2

1	802874	COUPLING MALE STUD, 8L-1/8 MNPT	2
1	77391	ELBOW, STREET ELBOW 1/8 NPT	2
1	802875	FITTING, MALE FEMALE TEE, FP-FP-MPT	2
1	802876	FITTING, GREASE 90 DEG, 1/8 NPT	2
1	W-104402	BLOCK, LUBE BLOCK, DRIVE CYLINDERS	1
1	801873-019	ADAPTOR - 08S X 1/4 BSPP	2
1	85659-015	HOSE, 4M2T-8FDHX-8FDHX-40.00	2
1	801888-002	SWIVEL ELBOW - 08L	1
1	85659-019	HOSE, 4M2T-8FDLX-8FDLX-20.00	2
1	801899-001	SWIVEL UNION - 08L	1
1	801873-003	ADAPTOR - 08L X 1/4 BSPP	2
1	801873-006	ADAPTOR - 12L X 1/2 BSPP	2
1	801486-001	HOSE, 8G6K-15FDLX-15FDLX-28.00	3
1	801879-002	TUBE ELBOW - 08L	1
1	B-123012	RING,FITTING RING DN 230, WATER BOX	2
1	W-102868	O-RING, 244 X 7, NBR70	2

WATERBOX TO HOPPER AREA

BOM Rank	Part Number	Part Description	Quantity
1	B-124021	RING, FLANGE RING - DN230 VER 2	2
1	W-103970	BOLT, SHCS, M20X120 DIN 912 10.9	14
1	W-100691	WASHER - M20 - DIN 6916	14
1	W-102868	O-RING, 244 X 7, NBR70	4
1	B-124019	CYLINDER, CONCRETE-203 X 2000 VER 2	2
1	801916	CLAMP, BAND CLAMP - 12 IN DIA	2
1	801171-003	C-RAIL - 8.25 LONG	2
1	801258	TUBE-HYD-PUMP CELL, 18L	1
1	801902-006	CLAMP,18MM TUBE CLAMP SET	2
1	801255	TUBE-HYD-PUMP CELL, 15L	3
1	801902-005	CLAMP,15MM TUBE CLAMP SET	6
1	801256	TUBE-HYD-PUMP CELL, 25L	2
1	801902-007	CLAMP, 25MM TUBE CLAMP SET	4
2	801902-001	NUT, TEE NUT, TUBE CLAMP	12

HOPPER AREA

BOM Rank	Part Number	Part Description	Quantity
1	801141	BRACKET, BULKHEAD, PUMP CELL	1
1	803135	ROD,RETAINER PUMPCELL BRKT801141	1
1	801145	CHANNEL, BULKHEAD BRACKET	1

1	801880-006	BULKHEAD ELBOW - 25S	2
1	801873-014	ADAPTOR - 25S X 1" BSPP	2
1	803127	WASHER, LOCK WASHER 1.5" 25MM PIPE	2
1	801829-010	BULLET, TUBE BULLET, METRIC, 25S	2
1	801488-001	HOSE, 12G6K-25FDHX-25FDHX-36.00	2
1	801878-004	BULKHEAD UNION - 18L	1
1	801829-005	BULLET, TUBE BULLET, METRIC, 18L	1
1	803125	WASHER, LOCK WASHER 18 MM PIPE	2
1	801485-009	HOSE, 6G6K-12FDLX-12FDLX-28.00	1
1	801829-004	BULLET, TUBE BULLET, METRIC, 15L	3
1	803126	WASHER, LOCK WASHER 15 MM	3
1	801878-003	BULKHEAD UNION - 15L	3
1	801880-004	BULKHEAD ELBOW - 15L	2
1	801891-004	TUBE REDUCER - 15L X 12L	2
1	B-125014	RING, FLANGE RING DN230 THREADED	2
1	W-106754	BOLT, SHCS, M20 X 80 DIN 912 10.9	12
1	W-100691	WASHER - M20 - DIN 6916	26

Förderzylinder kpl.
conveying cylinder cpl.

B 12 4 020

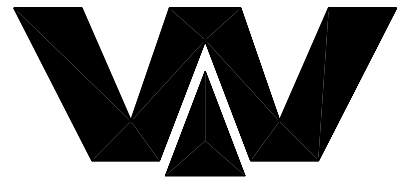

Waitzinger
Baumaschinen GmbH

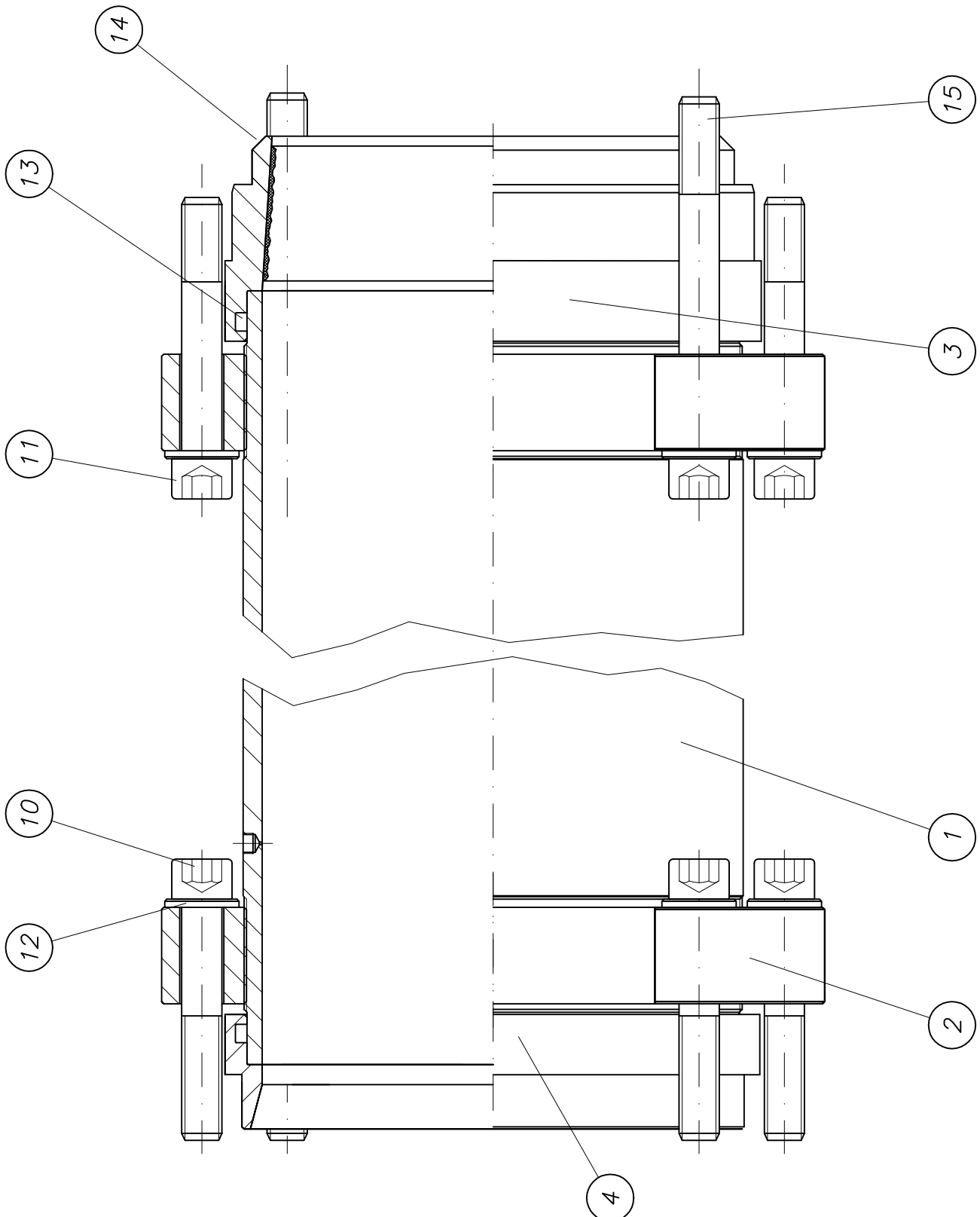



PARTS LIST

part list	description	created	index	valid from	valid to	
B124020	conveyor cylinder cpl. DN230/215x2000	17.03.00 Mi				
pos	description stock	ident-no dimensions	DIN material	index	weighth Kg	quantity unit
1	conveyor cylinder DN230x2000 chromized	B124019 Rohr 250x12.5x2	2448 St52.0		150,00	2,00 Stk
2	flange ring DN 230 threaded	B124021 Bl 55xd330	1543/EN10029 St52-3		12,20	4,00 Stk
3	fitting ring DN230/215 with hardened	B124015 Rohr 267x35x108	2448 St52.0		8,88	2,00 Stk
4	fitting ring DN 230 water box	B123012 Rohr 267x36x65	2448 St52.0		6,00	2,00 Stk
10	cheese head screw M20 x 120	WAI103970				14,00 Stk
11	cheese head screw M20 x 130	WAI104885				6,00 Stk
12	washer HV	WAI100691			0,01	28,00 Stk
13	O-ring 244 x 7, NBR70	WAI102868				4,00 Stk
14	O-ring 230x5	WAI101090				2,00 Stk
15	cheese head screw M20 x 180	WAI102845				8,00 Stk

Förderkolben kpl.
conveying piston cpl.

B 13 3 020

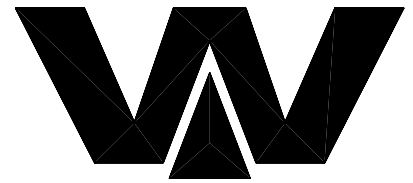

Waitzinger
Baumaschinen GmbH

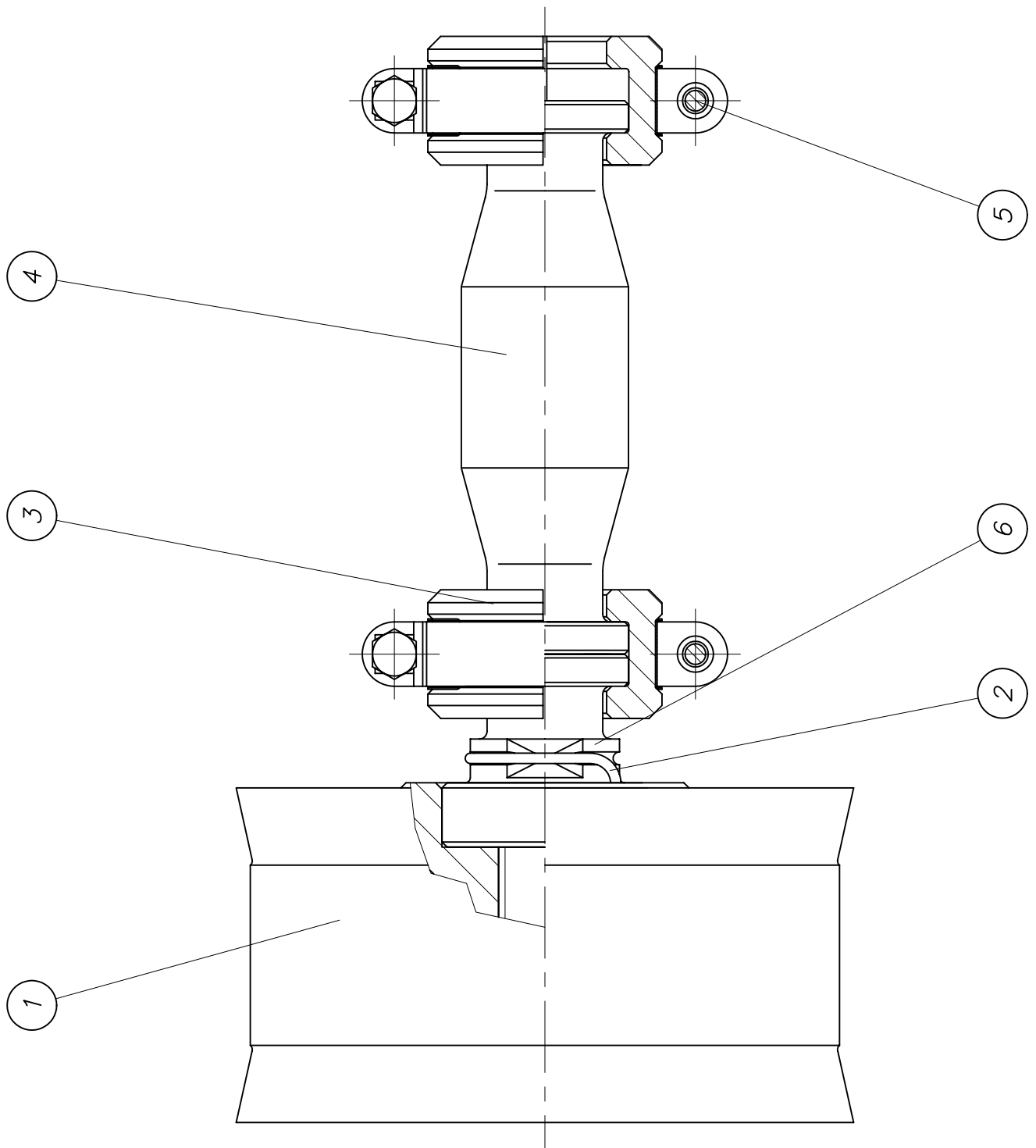



PARTS LIST

part list	description	created	index	valid from	valid to	
B133020	piston ram cpl. DN 230	08.07.98 Mi				
pos	description stock	ident-no dimensions	DIN material	index	weighth Kg	quantity unit
1	piston ram DN 230	WAI100175			19,90	2,00 Stk
2	protection ring	B133019 Federst. 4	17223			2,00 Stk
3	clamp coupling	B131004 Rd 95x50	1013 42CrMo4V			4,00 Stk
4	distance piece	B133003 Rd 70x225	1013 42CrMo4V			2,00 Stk
5	hose clamp S86/25	WAI101381			0,22	4,00 Stk
6	coupling bolt	B133018 Rd 82x120	1013 42CrMo4V		2,20	2,00 Stk

Spülkasten kpl.
water box cpl.

B 14 3 000

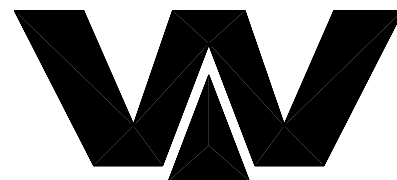

Waitzinger
Baumaschinen GmbH

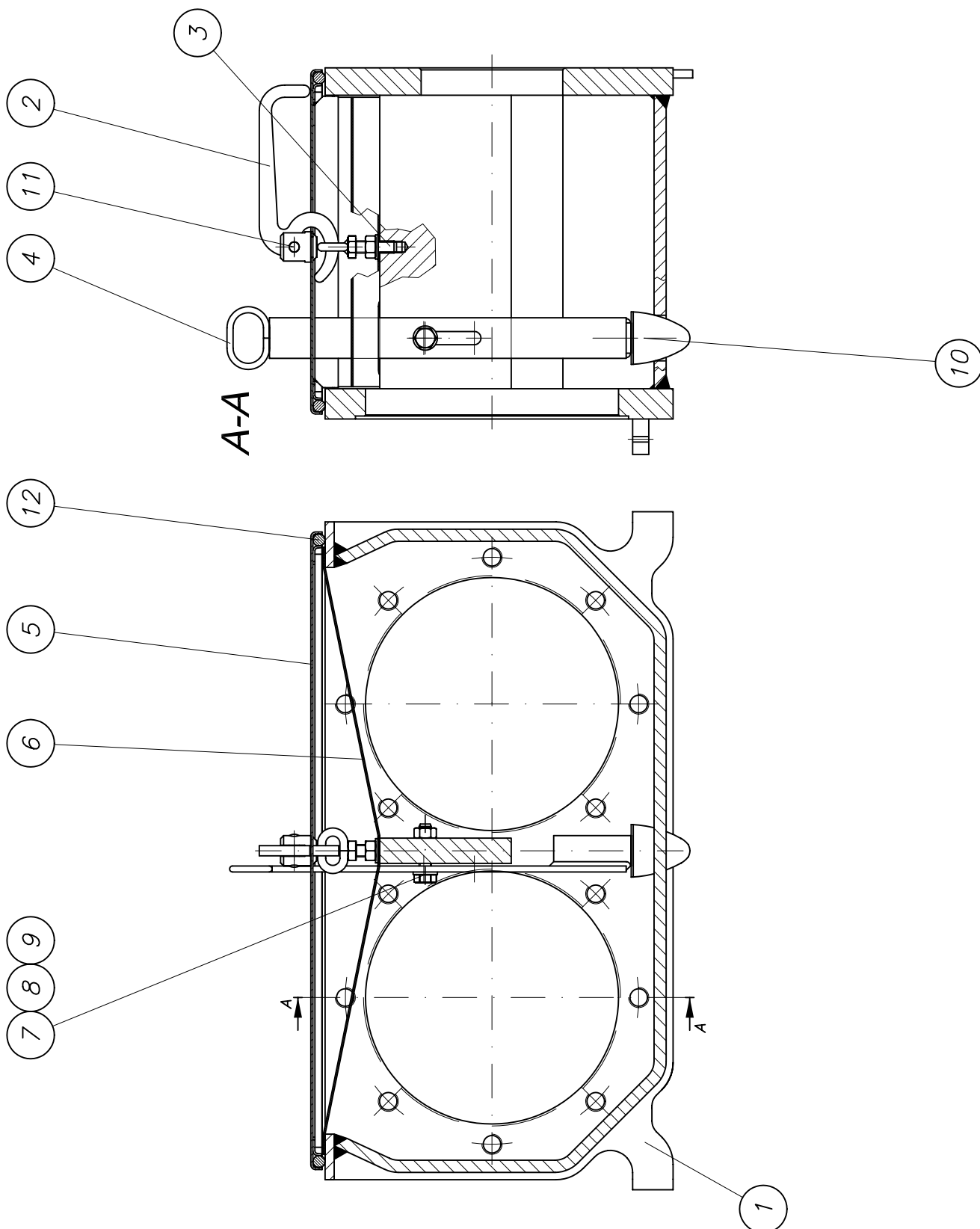



PARTS LIST

part list	description	created	index	valid from	valid to	
B143000	waterbox cpl. DN 200/230 plug	19.06.97 HG				
pos	description stock	ident-no dimensions	DIN material	index	weighth Kg	quantity unit
1	waterbox cpl. DN 200/230 (processing) own parts list	B143001		b 02.05.00		1,00 Stk
2	lever	B143007 Bl 10x195x78.5	1543/EN10029 St52-3			1,00 Stk
3	loop bolt cpl. own parts list	B143009			0,09	1,00 Stk
4	drain pin own parts list	B143011			1,14	1,00 Stk
5	cover for waterbox cpl. own parts list	B143015			4,55	1,00 Stk
6	savety lattice	B143020 Lochbl. 1.5x610	Rostfrei	a 28.05.03		1,00 Stk
7	hex. screw M12	WAI103688				1,00 Stk
8	nut M12 DIN 934	WAI101557			0,02	2,00 Stk
9	washer	WAI100504				2,00 Stk
10	rubber buffer 50 x 58	WAI102712				1,00 Stk
11	pin	WAI103387				1,00 Stk
12	O-ring cord 12mm	WAI101831				1,95 Mtr

Antriebszylinder kpl.
drive cylinder cpl.

B 15 4 032

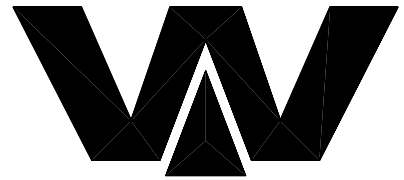

Waitzinger
Baumaschinen GmbH

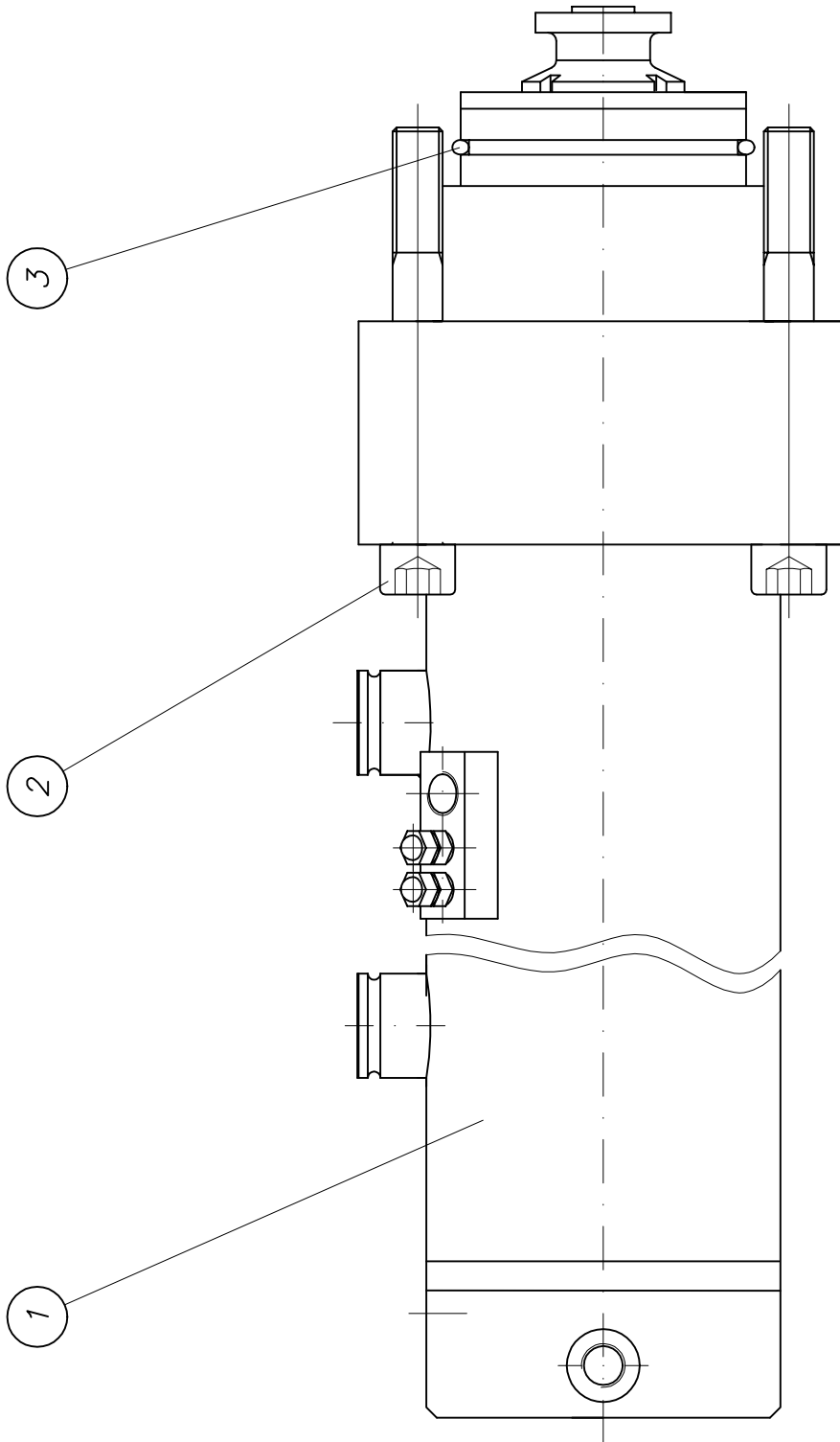



PARTS LIST

part list	description	created	index	valid from	valid to	
B154032	drive cylinder cpl. 125/80-2000	20.09.00 Mi				
pos	description stock	ident-no dimensions	DIN material	index	weigh Kg	quantity unit
1	drive cylinder 125/80-2000 own parts list	WAI106355		a 30.10.03	280,00	2,00 Stk
2	cylinder head screw M 24 x 200	WAI103828				8,00 Stk
3	O-ring 129,2 x 5,7	WAI101441				2,00 Stk

Antriebszylinder kpl.
drive cylinder cpl.

WAI 106355a

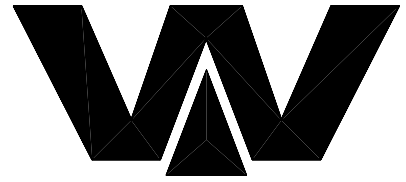

Waitzinger
Baumaschinen GmbH

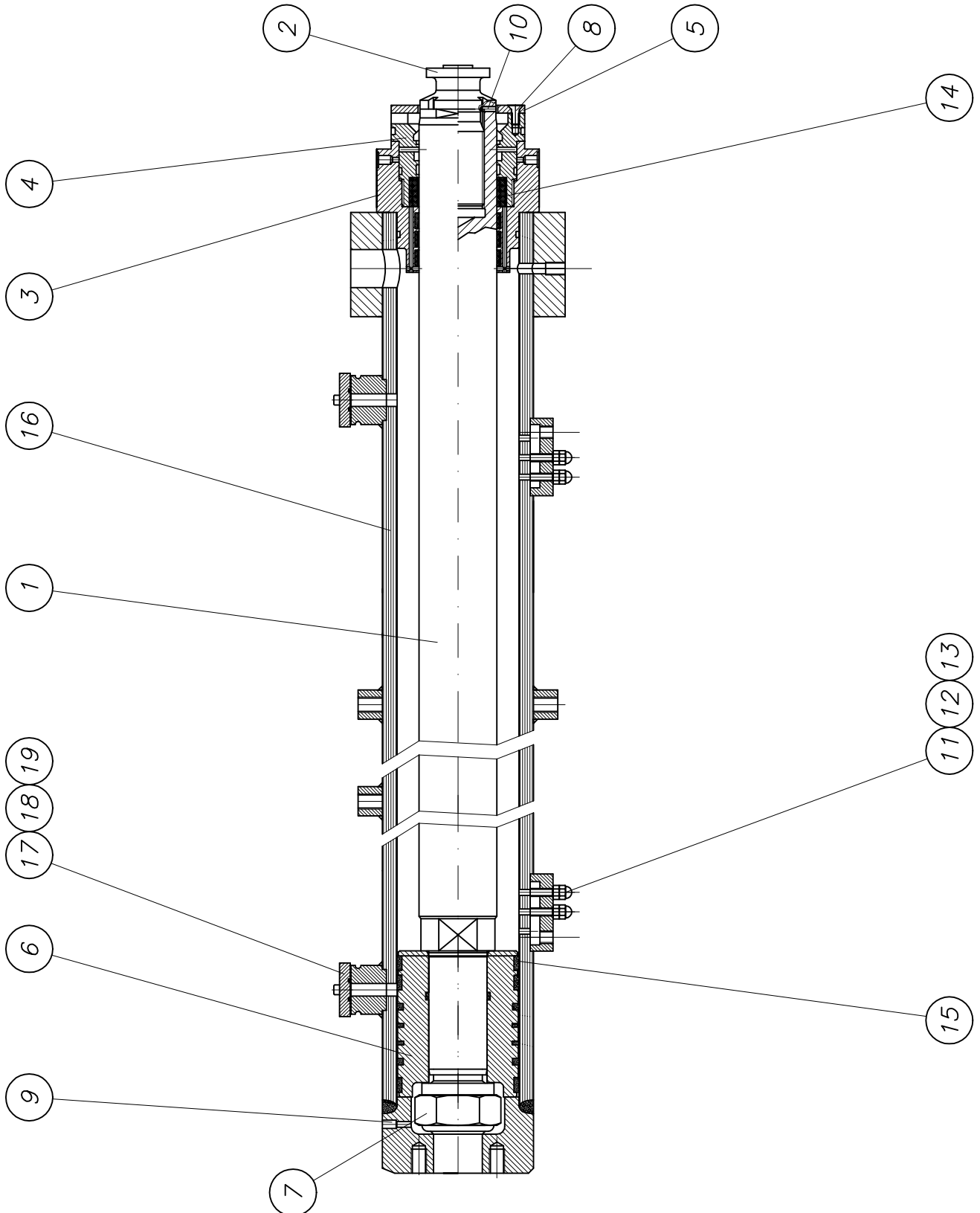



PARTS LIST

part list	description	created	index	valid from	valid to	
WAI106355	drive cylinder 125/80-2000	06.09.00 hbk	a	30.10.03		
pos	description stock	ident-no dimensions	DIN material	index	weigh Kg	quantity unit
1	piston rod for drive cylinder	WAI105724 Rd 90x2173	1013 Ck45			1,00 Stk
2	piston joint	WAI104146 Rd 80x131	1013 42CrMo4V		1,87	1,00 Stk
3	guide piece for drive cylinder 125	WAI105950 Rd 180x142	1013 St52	a 21.07.03		1,00 Stk
4	sealing carrier for drive cylinder	WAI104890	GGG 40	a 29.07.03		1,00 Stk
5	aperture for drive cylinder	WAI105726 8x d137	Polyamid			1,00 Stk
6	piston 125	WAI106353		b 21.07.03	13,00	1,00 Stk
7	piston nut for drive cylinder	WAI105728				1,00 Stk
8	sunk screw M 8 x 20	WAI103397				3,00 Stk
9	locking screw G 1/8	WAI100528				3,00 Stk
10	set screw	WAI105739				1,00 Stk
11	hex. nut M8 DIN 934 8. VERZ.	WAI102880				4,00 Stk
12	cap nut M8	WAI104933				4,00 Stk
13	set screw	WAI105740				4,00 Stk
14	sealing set for drive cylinder 125/80 own parts list	WAI104690				1,00 Stk
15	sealing set for drive cylinder 125/80 own parts list	WAI106354				1,00 Stk
16	cylinder pipe cpl. 125	WAI106148		b 21.07.03		1,00 Stk
17	cover for sensor connection	B154017 Rd 11x55	1013 S235J2G3		0,20	2,00 Stk
18	o-ring	WAI108533				2,00 Stk
19	alien bolt M 6x25	WAI103673				4,00 Stk

Stangendichtsatz

rod sealing set

WAI 104690

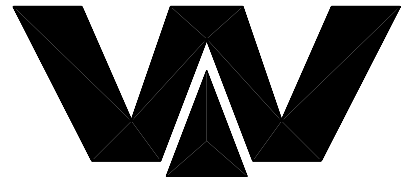

*Waitzinger
Baumaschinen GmbH*

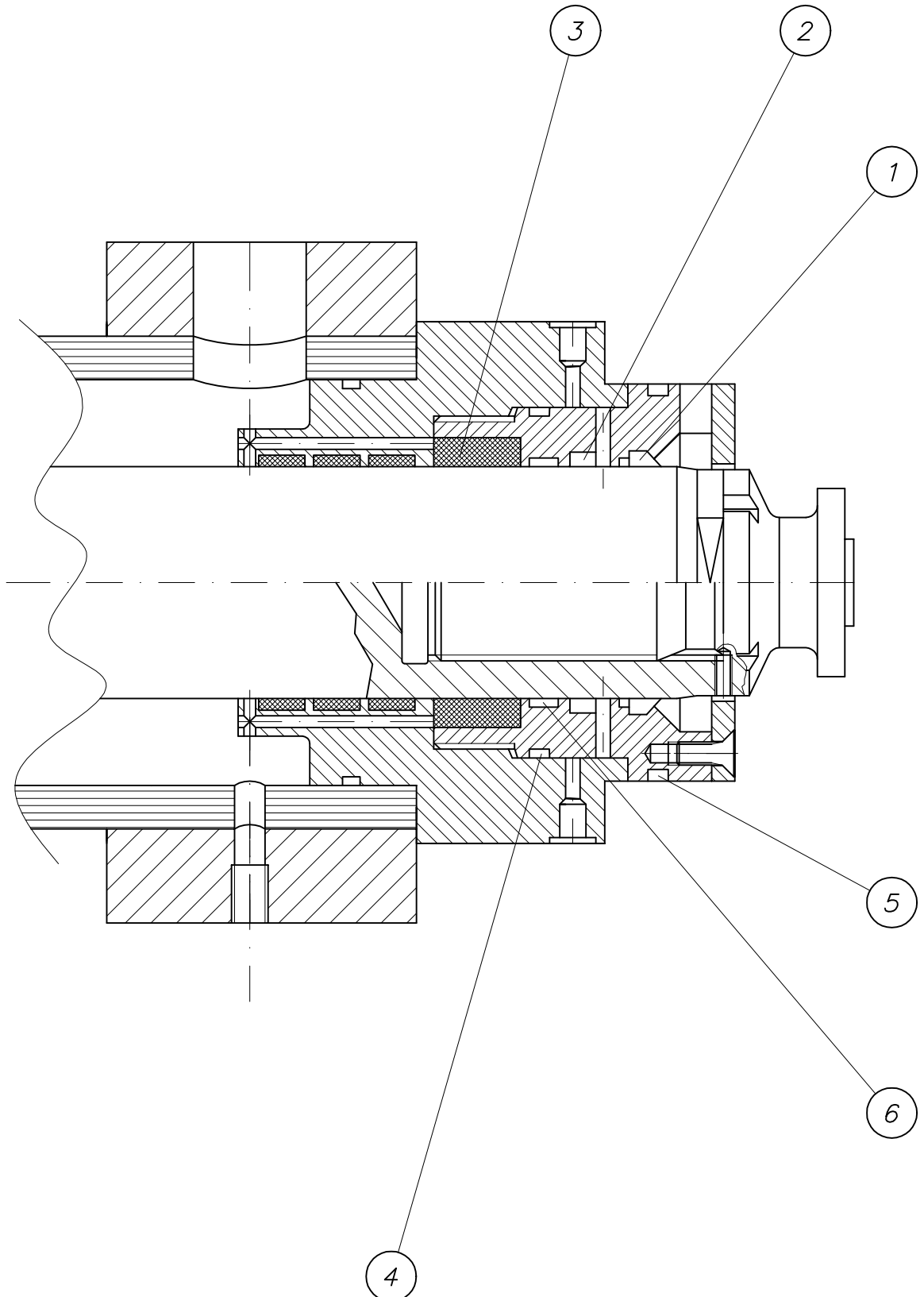



PARTS LIST

part list	description	created	index	valid from	valid to	
WAI104690	sealing set for drive cylinder 125/80	30.08.99 Mi				
pos	description stock	ident-no dimensions	DIN material	index	weighth Kg	quantity unit
1	wiper	WAI100259			0,00	1,00 Stk
2	wiper	WAI105729				1,00 Stk
3	v-packing 80 x 100 x 30	WAI102584				1,00 Stk
4	sealing for drive cylinder	WAI105732				1,00 Stk
5	o-ring	WAI105731				1,00 Stk
6	rod support for drive cylinder	WAI105738				1,00 Stk

Dichtsatz für Antriebszylinder
sealing set for drive cylinder

WAI 106354

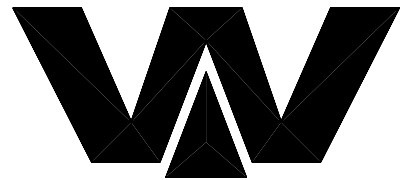

Waitzinger
Baumaschinen GmbH

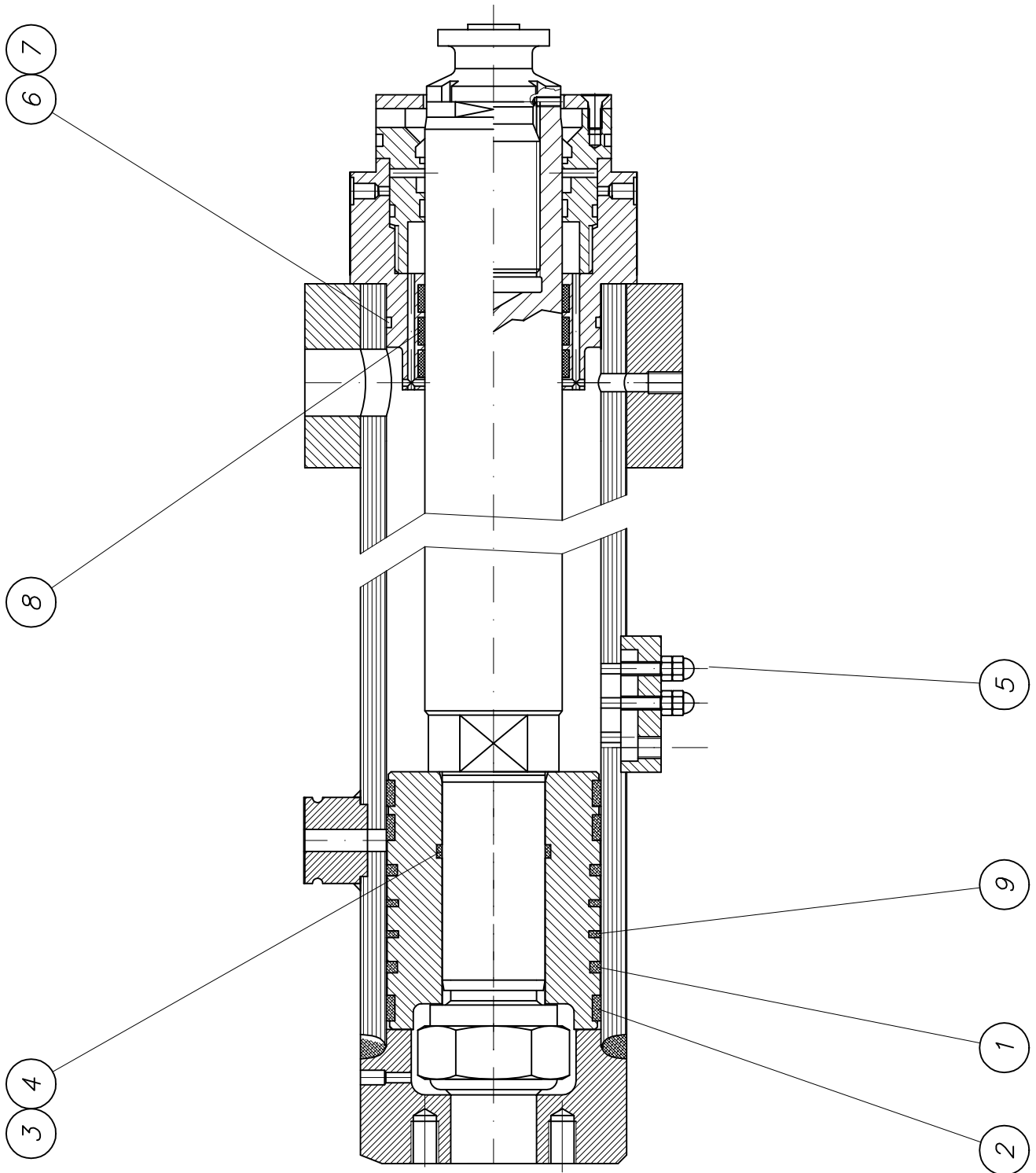



PARTS LIST

part list	description	created	index	valid from	valid to	
WAI106354	sealing set for drive cylinder 125/80	06.09.00 hbk				
pos	description stock	ident-no dimensions	DIN material	index	weigh Kg	quantity unit
1	piston ring permasel DN125	WAI100260			0,05	2,00 Stk
2	rod support for drive cylinder	WAI105738				3,00 Stk
3	back-up ring	WAI105736				2,00 Stk
4	o-ring	WAI105734				1,00 Stk
5	usit-ring 8.7-14-1	WAI101269				8,00 Stk
6	back-up ring	WAI105951				1,00 Stk
7	o-ring	WAI105952				1,00 Stk
8	rod support for drive cylinder	WAI105730				3,00 Stk
9	piston ring	WAI106357				2,00 Stk