

SCALE		WEIGHT	
M 42.5		XXT	
control panel V4			
Page 1			
FREE DIMENSION TOLERANCE DIN 7168 MEDIUM		DATE	NAME
DRAWN 2000/03/27		CHKD.	Felzer
APPD.			
CHANGE ONLY WITH CAD			
d	siehe B_513017.doc	19.07.05	Körner
c	siehe B_513017.doc	24.02.05	Körner
b	siehe B_513017.doc	02.02.04	Körner
a	siehe B_513017.doc	15.01.04	Körner
ISSUE	MODIFICATION	DATE	NAME

THIS INFORMATION MAY NOT BE COPIED BY A THIRD PARTY. SUBJECT TO COPYRIGHT (PARAGRAPH 1 NO. 3 OF "URheberRECHTSGESETZ" FROM 14.06.1991)

P12.2a P12.2b P12.2c P12.2d

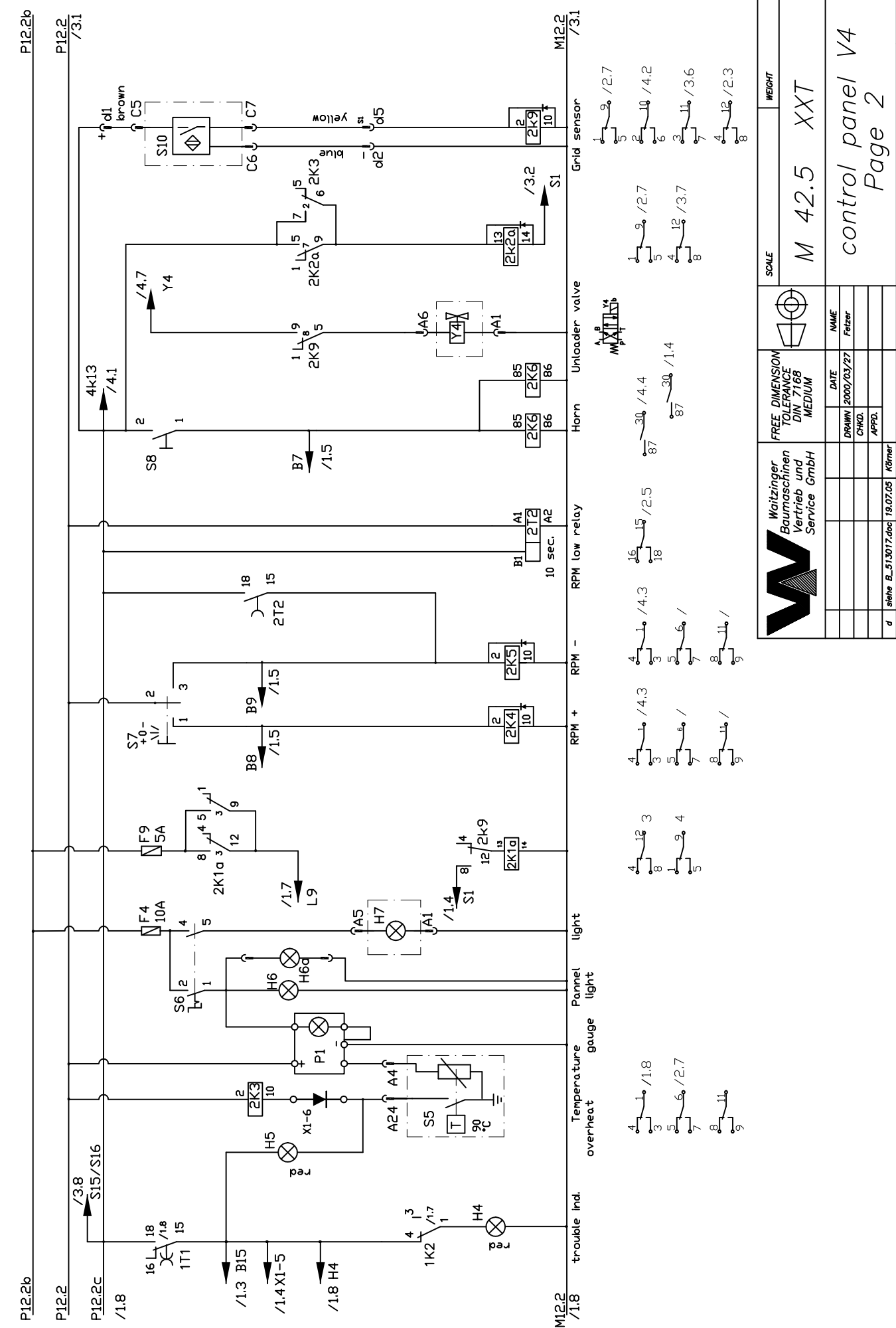

SCALE		WEIGHT	
M 42.5		XXT	
control panel V4			
Page 2			
FREE DIMENSION	DATE	NAME	
TOLERANCE	DRAWN	DATE	NAME
DIN 7185	2000/03/27	Fetzer	
MEDIUM	CHKD.		
	APPD.		
d	siehe B_513017.doc	19.07.05	Körner
c	siehe B_513017.doc	24.02.05	Körner
b	siehe B_513017.doc	02.02.04	Körner
a	siehe B_513017.doc	15.01.04	Körner
ISSUE	MODIFICATION	DATE	NAME
CHANGE ONLY WITH CAD		ORIGINAL	
REPLACEMENT FOR		REPLACEMENT BY	
B 51 3 017			
SHEET		OF	

THIS INFORMATION MAY NOT BE COPIED BY A THIRD PARTY. SUBJECT TO COPYRIGHT (PARAGRAPH 1 NO. 3 OF "URheberRECHTSGESETZ" FROM 14.06.1991)

P12.3a P12.3b P12.3 P12.3c P12.3d

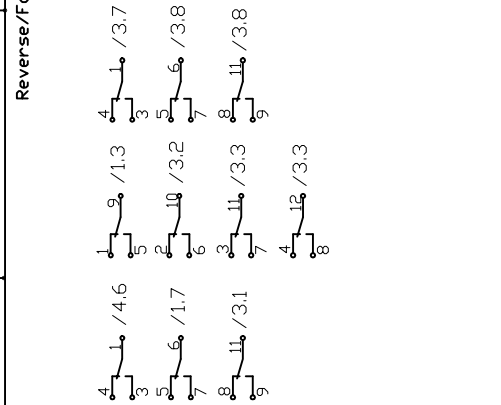
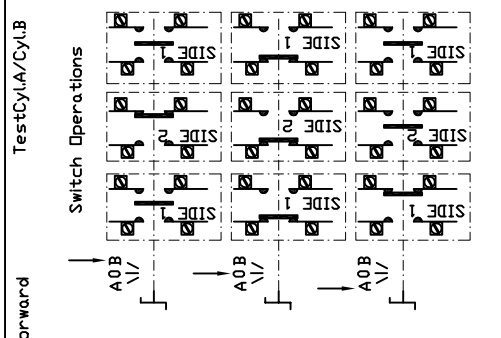
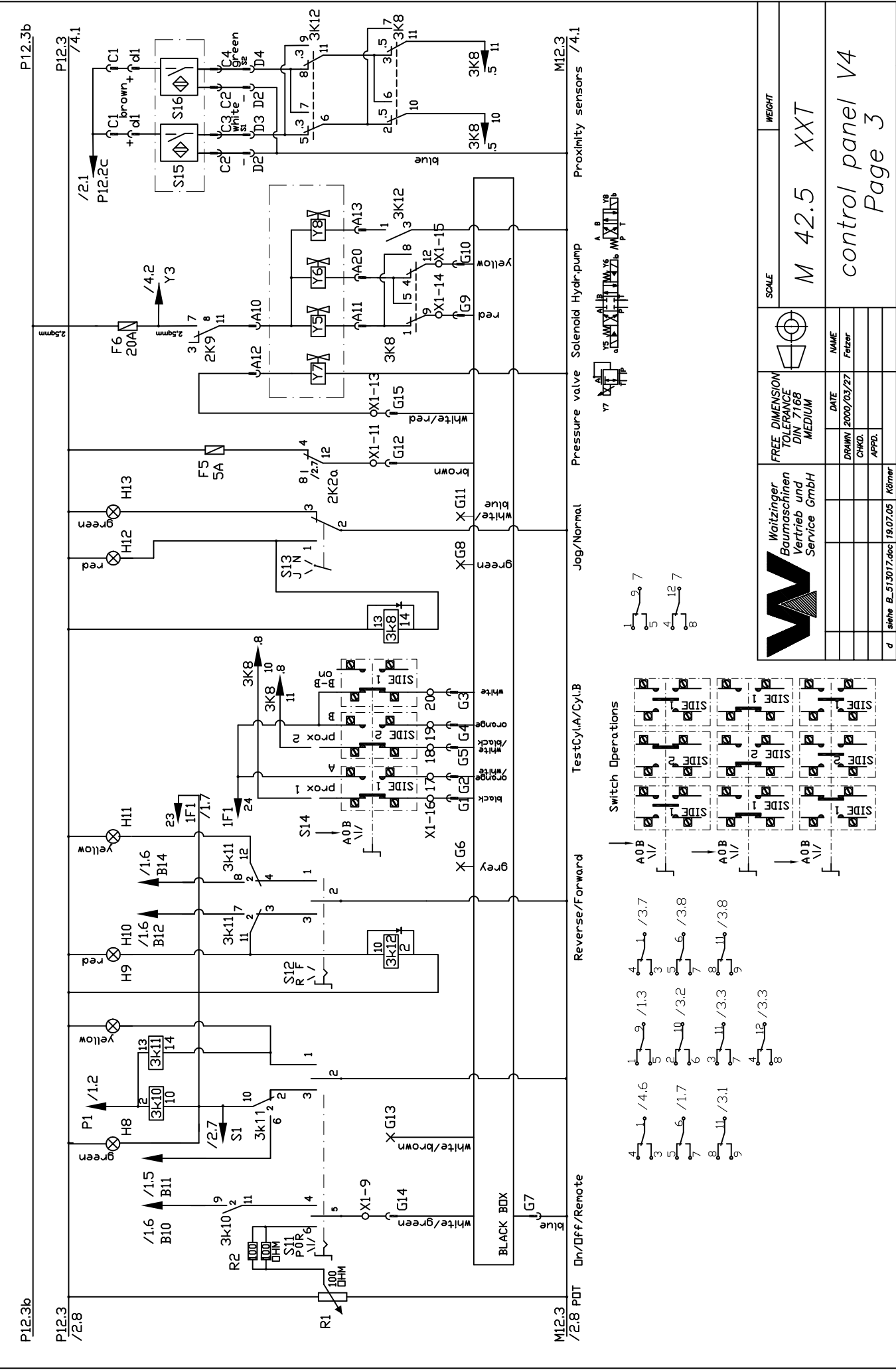

SCALE M 42.5 control panel V4 Page 3		WEIGHT	
FREE DIMENSION TOLERANCE DIN 7168 MEDIUM		DATE DRAWN 2000/03/27 CHKD. APPD.	
Waizinger Baumaschinen Vertrieb und Service GmbH		NAME Felzer	
CHANGE ONLY WITH CAD		ORIGINAL	
B 51 3 017		REPAIRMENT BY	
SHEET OF		REPLACEMENT FOR	

THIS INFORMATION MAY NOT BE COPIED BY A THIRD PARTY. SUBJECT TO COPYRIGHT (PARAGRAPH 1 NO. 3 OF "URheberRECHTSGESETZ" FROM 14.06.1997)



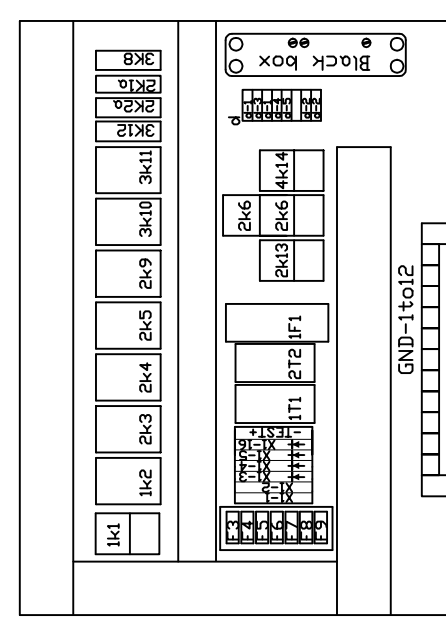
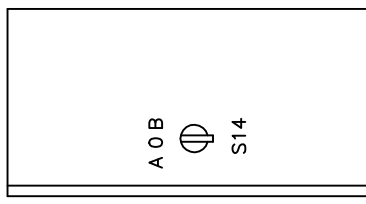
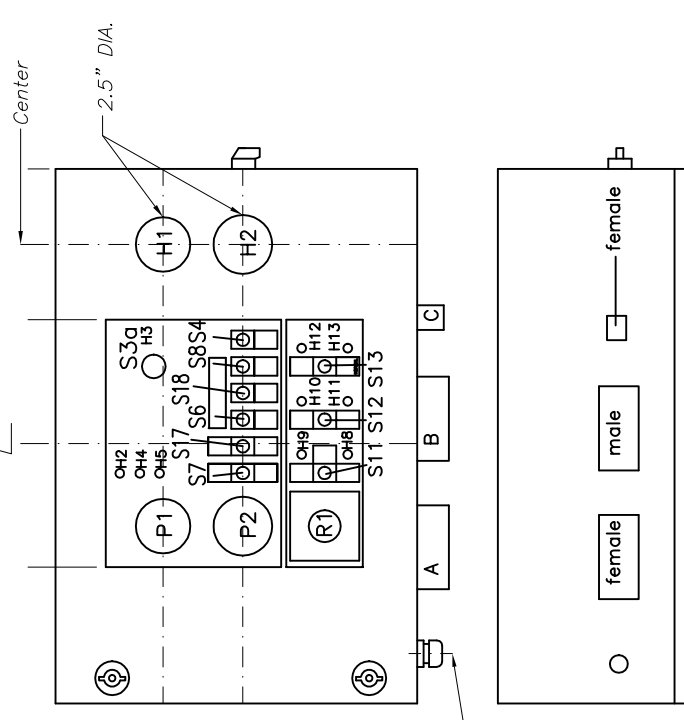

4K14 + 2K6

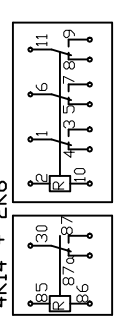

THIS INFORMATION MAY NOT BE COPIED BY A THIRD PARTY. SUBJECT TO COPYRIGHT (PARAGRAPH 1 NO. 3 OF "URheberRECHTSGESETZ" FROM 14.06.1991)

	FREE DIMENSION TOLERANCE	SCALE	WEIGHT
	DIN 7168 MEDIUM	M 42.5	XXT
DATE	NAME	control panel V4 Page 5	
2000/03/27	Felzer		
CHKD.		CHANGE ONLY WITH CAD	
APPD.			
ISSUE	MODIFICATION	DATE	NAME
d	siehe B_513017.doc	19.07.05	Körner
c	siehe B_513017.doc	24.02.05	Körner
b	siehe B_513017.doc	02.02.04	Körner
a	siehe B_513017.doc	15.01.04	Körner
REPLACEMENT FOR		REPLACEMENT BY	
B 51 3 017		SHEET	
		OF	