

AL-KO **AXIS**

- **Axles & Parts**
- **Trailer Accessories**
- **ESC - Towing Safety**
- **Metal Fabrication**
- **Agricultural Products**

Owner's Manual

AL-KO  **AXIS**



WWW.AL-KOAXIS.COM

574-294-6651

USA WORLD HEADQUARTERS • ELKHART, IN

Information contained in this publication was in effect at the time the publication was approved for printing and is subject to change without notice or liability.

MAN500-7K0414

**Axles, Brakes, Hubs and Drums
500 lbs. to 7,000 lbs.**

Table of Contents

Introduction.....	4
Safety.....	5
Electric Brake Operation.....	6-7
Before The First Trip.....	8-10
General Maintenance.....	11
Storage Maintenance.....	12
Service Preparation.....	13
Brake Assemblies.....	14-19
Adjustment.....	14
Shoe & Lining.....	15-16
Magnet.....	17-19
Bearings, Races and Seals.....	20-21
Brake Drum.....	22-23
Completing Service.....	24
Tire Inspection.....	25-26
Troubleshooting.....	27-30
Suspension Components.....	31-33
Replacement Parts.....	34-43
Warranty.....	45



Approved



Introduction

AL-KO Axis, Inc. (“AL-KO”) is a major supplier to the light trailer industry. Our axles, brakes, hubs and drums are in operation around the world, helping trailers tow smoothly and stop safely. Our product line is the result of years of advanced engineering in the United States as well as Germany, where vehicular technology is unsurpassed. AL-KO products have undergone years of exhaustive testing and we continue to strive for superior reliability, safety and performance.

This manual contains information about axle assemblies, attaching parts, electric brakes and hub/drum assemblies.



Leaf Spring Axle Assemblies



Rubber Torsion Axle Assembly



*Attaching Parts For
Leaf Spring Axles*

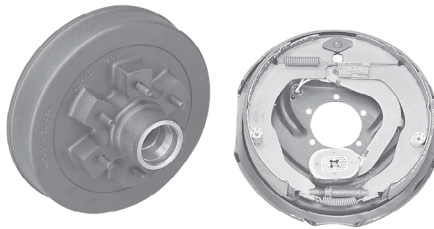

Hub/Drum and Electric Brake

Adhering to the recommended service schedule on page 11 will ensure the finest towing and stopping action available.

Safety First

This manual describes service and repair procedures for AL-KO Axis, Inc. ("AL-KO") trailer axles. Technicians must follow their employer's procedures and these procedures when servicing or repairing equipment or components. Before performing any service or maintenance, review the trailer manufacturer's recommendation for procedures and warnings.

The service and maintenance procedures are provided for use by qualified service technicians. Do not attempt to service, repair or work on brakes or axles unless you have appropriate mechanical knowledge and skills. You must understand all procedures and instructions before you begin to work on a unit. Some procedures require the use of special tools for safe and correct service. Failure to use special tools when required can cause damage to equipment and components. Lack of proper training, failure to follow proper procedures, or not using proper tools or safety equipment, can result in property damage, serious personal injury, or loss of life.

The following symbols are used to warn the user of potential dangers that could cause serious damage to equipment or cause personal injury or death.

 **WARNING** *This indicates a procedure that you must follow exactly to avoid damaging equipment or components and to avoid serious personal injury, or loss of life.*

 **FASTENER TORQUE WARNING** *Fasteners must be tightened to a specific torque value. The technician must use the proper torque wrench to perform these operations. Improper torque can result in product failure which could cause property damage, serious injury, or loss of life.*

 **ASBESTOS FIBER WARNING** *Current AL-KO and Hayes brake linings are asbestos free. Other brake linings may contain asbestos fibers, a cancer and lung disease hazard. Many brake linings contain non-asbestos fibers, whose long-term effects to health are unknown. You must use caution when you handle both asbestos and non-asbestos materials. (See page 15.)*

DANGER
 **SAFETY GLASSES REQUIRED** *To prevent serious eye injury, always wear safety eye protection when you perform vehicle maintenance or service.*

Electric Brake Operation

AL-KO Axis, Inc. electric brakes are cam actuated, self energizing drums brakes. Their operation is similar to automotive drum brakes but the actuation system is different. Electric brakes are actuated electrically through a magnet rather than hydraulically through a wheel cylinder. The magnet is positioned so its poles are close to an armature surface, which is machined or bolted inside the brake drum. When the magnet is energized, it is attracted to the armature surface causing a frictional force that pivots the lever arm and slipper block. This forces the primary shoe against the drum which energizes the secondary shoe.

Electric Brake Assembly
(10" Left Hand Shown)

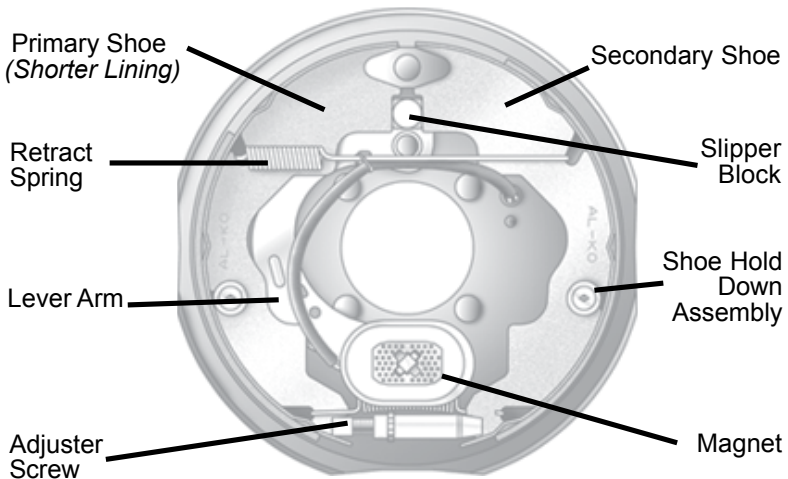

← Trailer Front

Typical Brake System

AL-KO Axis, Inc. ("AL-KO") supplies electric brake assemblies as shown on the opposite page. Many components make up the entire "braking system". Several components are **not supplied by AL-KO** including:

Brake Controller
Resistors
Connectors
Break-away Switch
Battery
Fuses
Wire Harness.

The specific components on your braking system may vary at the discretion of the trailer manufacturer or dealer. Below is a schematic showing possible components and general locations.

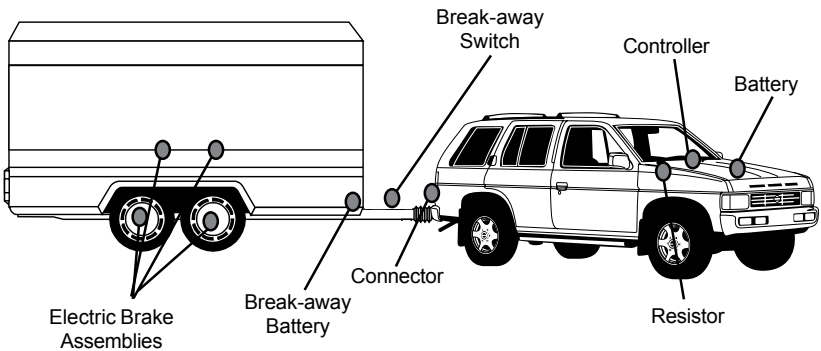

Of this total system, AL-KO supplies the brake assemblies. Since proper function of your brakes depends on many components, please follow the vehicle or component manufacturer's recommendations when installing, using or servicing these components.

Before The First Trip

① **Adjust brakes** after the first 200 miles and then as outlined on page 11. A “green brake” is an unburnished brake. Normal manufacturing tolerances dictate that there is a break-in period required after which the lining will seat and become perfectly concentric with the drum. During this break-in period, the user must be aware that additional brake adjustments are mandatory to achieve optimum braking performance.

 **WARNING** *Failure to adjust brakes can result in brake lockup, reduced brake performance, or total loss of brakes which can lead to serious personal injury or loss of life.*

② **Set the hitch or pin height** of the tow vehicle so that the trailer is being pulled in a horizontal position. Trailers must be towed as level as possible. If the trailer leans down in the front it will distribute too much weight to the front axle. If the hitch or pin height is too high, the rear axle will receive too much of the load. Either condition can overload an axle even if the trailer is not overloaded.

 **WARNING** *Improper trailer position can cause tow vehicle handling problems resulting in property damage, serious personal injury, or loss of life.*

③ **Set wheel nut torque** as it may loosen several times before the wheel is properly seated to the wheel mounting surface. Wheel nut torque must be checked with a torque wrench and adjusted if necessary. Do not overtighten. Be sure to follow the instructions on page 24.

 **FASTENER TORQUE WARNING** *Torque wheel nuts now and then every fifty miles for the first 200 miles and then according to the schedule on page 11. Over or under torqued wheel nuts can cause the wheel to separate from the wheel mounting surface during operation. Wheel separation can result in property damage, serious personal injury, or loss of life. (See page 25 for torque specifications.)*

Before The First Trip

- ④ **Synchronize the trailer brakes** with the tow vehicle brakes. Trailer brakes are designed to stop the trailer. They cannot stop both the tow vehicle and trailer. Improper synchronization between the trailer and tow vehicle brakes can overload the brakes and generate excessive heat, causing brake fade or failure. Proper synchronization is achieved when the trailer's brakes have a slight lead over the tow vehicle's brakes. This is accomplished by adjusting the brake controller. There are several types of brake controllers available. See the manufacturer's recommendation for adjusting the controller. When done properly, there should be no sensation of the trailer "pushing" or "pulling" the tow vehicle.

 **WARNING** *Road test before using. Be sure area is clear of traffic and pedestrians. Do not exceed 30 m.p.h. Follow procedures outlined by the controller manufacturer. Failure to do so could result in property damage, serious personal injury, or loss of life.*

- ⑤ **Weigh the trailer** after it is fully loaded and ready for use. Axles, brakes, wheels, tires, frames and suspension components are designed to carry a specific maximum weight. Locate the VIN (Vehicle Identification Number) plate on the trailer. It will show the GVWR (Gross Vehicle Weight Rating). The GVWR is the total amount your trailer (including tongue weight) can weigh when it is completely loaded including holding tanks, propane etc. The GAWR (Gross Axle Weight Rating) is the maximum load that the axles will carry and the maximum load the brakes will stop. Follow the instructions on page 10 for weighing the trailer and determining weight distribution.

 **WARNING** *Exceeding the GVWR (Gross Vehicle Weight Rating), the GAWR (Gross Axle Weight Rating) or having improper weight distribution can result in reduced performance or failure of the axle(s), brakes, and other suspension components. This failure can lead to property damage, serious personal injury, or loss of life.*

Weighing The Trailer

Find a scale large enough to weigh the trailer. They are generally available at truck stops, concrete yards, grain elevators, etc.

- ① First, weigh the trailer in its entirety (including the tongue weight) while detached from the tow vehicle. This weight must be less than the GVWR (Gross Vehicle Weight Rating) on the VIN plate. If overweight, contents must be unloaded until it is within the GVWR limits.
- ② Attach the trailer to the tow vehicle. Weigh the total of all trailer wheels making sure the tow vehicle is off of the scale. If this reading exceeds the GAWR, contents must be unloaded.

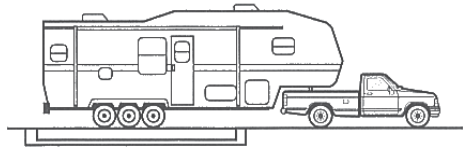

It is equally important that the load is distributed evenly among all of the axles and wheels. **One axle or wheel may be overloaded even if the GVWR and GAWR weights are within limits.**

- ③ Pull the trailer forward until the front axle is off of the scale. On tandem axle trailers, both axles should be carrying about the same load. If not, level the trailer or redistribute the load.

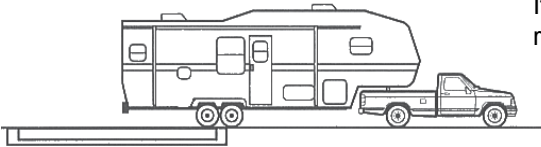

- ④ For triple axle trailers, pull the trailer forward again until the front two axles are off the scale. Calculate the weight of each axle and balance accordingly.

Also, check weight distribution at each wheel. Use the above technique weighing only the right or left side. Calculate the weight at each wheel. **Be sure that no one wheel is overloaded.** If you have trouble calculating or interpreting the weights, contact your dealer or vehicle manufacturer.

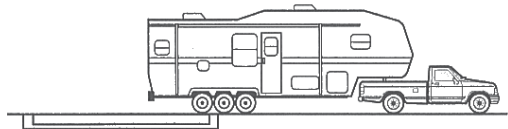

General Maintenance

To keep a trailer towing smoothly and stopping safely it is recommended that service be done at the intervals below. (*Severe conditions including excessive brake use, extremely rough roads, etc. may require more frequent maintenance.*)



WARNING

Improper or inadequate maintenance could result in premature wear or component failure which could result in property damage, serious personal injury, or loss of life.

Component	Check	Break-In Service Service During "Break In" Period	Standard Service Schedule				Reference
			Daily	Weekly	6,000 Miles or 6 Months whichever comes first	12,000 Miles or 12 Months whichever comes first	
Trailer Brakes	Test for proper function.	Before First Trip	✓				See Controller Manufacturer's Instructions
Tires	Inflate to proper pressure. Check for abnormal wear.	Before First Trip	✓				Page 25
Wheel	Inspect for damage, nicks, or out of round.	Every 50 miles for first 200 miles			✓		See Wheel Manufacturer's Instructions
Wheel Nuts (Lug Nuts)	Tighten to proper torque specs.	Every 50 miles for first 200 miles	Repeat "Break-In Service whenever wheel is removed		✓		Page 24
Break-away Switch	Check for proper function. Inspect connections.	Before First Trip	✓				See Manufacturer's Instructions
Break-away Battery	Check for proper function. Inspect connections.	Before First Trip		✓			Measure Voltage
Brake Adjustment	Test brake drag and adjust if required.	After First 200 Miles			✓		Page 14
Brake Assembly	Check for adequate lubrication	None				✓	Page 16
Brake Magnets	Inspect for uneven wear.	None				✓	Pages 17-18
Wheel Bearings	Repack bearings, inspect for wear or damage.	None				✓	Pages 20-21
Hub/Drum Assemblies	Check for heavy scoring or wear.	None				✓	Pages 22-23
Seals	Inspect for damage or wear.	None				✓	Pages 20-21
Springs	Check for broken, separated or flattened springs.	Check After First 500 Miles				✓	Visual Inspection
Suspension Components	Check fastener torque and for worn or bent parts.	Visually Check After First 500 Miles.				✓	Pages 30-31

Storage Maintenance

Before Storing

- ① Disconnect the break-away battery and store indoors. Periodically check and recharge if necessary
- ② Park trailer on a level area.
- ③ Lift trailer per instructions on page 13.
- ④ Place auxiliary blocking under the frame so that all weight is removed from the wheels.

 **WARNING** See manufacturer's recommendation for position of blocks. Never use the axle or any portion of the suspension to lift or support the trailer. This will damage the axle and lead to premature failure which could result in property damage, serious personal injury, or loss of life.

- ⑤ Lubricate the moving suspension parts. (See page 31.) If axles have been exposed to immersion or excessive moisture, check hub/drum and bearing for moisture and repack if necessary. (See page 20-21.)
- ⑥ Hot or warm grease may settle in the hub/drum. Rotate the wheel after one to two weeks to redistribute grease.

After Storage (Two Months or Longer)

- ① Follow instructions on page 13 for "Service Preparation". Mark location for each wheel and hub/drum. They will be reinstalled on the same spindle.
- ② Check suspension for wear and proper fastener torque. (See page 30.)
- ③ Install a fully charged break-away battery.
- ④ Follow all hub/drum and brake service procedures. Replace or repair any worn or damaged parts. **Be sure to repack bearings.** (See pages 20-21.)
- ⑤ Reinstall hub/drums and wheels in same position as removed.

 **FASTENER TORQUE WARNING** Wheel nut torque must be checked with a torque wrench and adjusted if necessary. Do not overtighten. Be sure to follow the instructions on page 24.

Service Preparation

The service and maintenance procedures are provided for use by qualified service technicians. Do not attempt to service, repair or work on brakes or axles unless you have appropriate mechanical knowledge and skills. You must understand all procedures and instructions before you begin to work on a unit. Some procedures require the use of special tools for safe and correct service. Failure to use special tools when required can cause damage to equipment and components. Lack of proper training, failure to follow proper procedures or not using proper tools or safety equipment, can result in property damage, serious personal injury, or loss of life.

Lifting Trailer

Many service and maintenance procedures require the trailer to be elevated. Follow the trailer manufacturer's recommendations for lifting the trailer.



WARNING

Do not work under a vehicle supported only by jacks or jack stands. Use additional auxiliary blocking. Jacks or jack stands could fail resulting in property damage, serious personal injury, or loss of life.

- ① Lift the trailer until wheel rotates freely and secure trailer with appropriate jacks and auxiliary blocking. ***Never use the axle or any portion of the suspension to lift or support the trailer. This will damage the axle and lead to premature failure.***
- ② If service requires the hub/drum to be removed, remove the wheel and follow steps 3-5. ***Refer to the schematic on page 22-23.***



ASBESTOS FIBER WARNING

- ③ Remove the hub/drum assembly by removing the grease cap, cotter pin, castle nut, spindle washer (where required) and outer bearing. If a bearing drops it may be damaged and should be replaced. Pull the drum straight off the spindle being careful not to damage the spindle, bearings or races. The inner bearing and seal may stick to the spindle. If so, use a bearing puller to remove inner bearing.
- ④ Pry the seal with a seal removing tool or screw driver. Do not drive seal out by hitting, punching, or tapping the inner bearing.
- ⑤ Wash bearings and races with solvent. Do not use water or steam as they may damage components or cause components to come loose. Apply a thin layer of grease until ready to repack.

Brake Adjustment

- ① Lift trailer as outlined on page 13 "Service Preparation".
- ② **Do not remove the wheels or hub/drum assembly.**
- ③ Locate the adjusting slot at the bottom of the backing plate and remove the protective cover
- ④ While spinning the wheel, use a standard brake adjusting tool or the blade of a screw driver to rotate the star wheel until there is a heavy brake drag.
- ⑤ Loosen until the wheel turns freely about 3/4 to one full turn.
- ⑥ Replace the protective plug to keep dirt and moisture out.
- ⑦ Replace all parts and lower trailer as outlined on page 24 "Completing Service".
- ⑧ Repeat procedure for other wheels. Never adjust just one brake. It is recommended that all brakes on the trailer, or at least both brakes of one axle, be adjusted at the same time.

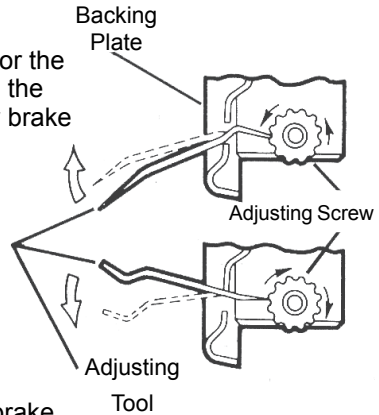

WARNING

Improper brake adjustment can result in reduced brake performance or loss of brakes. Reduced brake performance can lead to property damage, serious personal injury, or loss of life.

Replacing Complete Brake Assembly

- ① Follow "Service Preparation" instructions on page 13.
- ② Remove fasteners which attach the brake backing plate to the brake flange. See schematics on pages 33-41.
- ③ Install new brakes. Be sure to use the proper side and install the brake with the magnet on the bottom. Reinstall fasteners. 7/16" fasteners (7" & 10" brakes) and 3/8" fasteners (12" brakes) Should be torqued to 32 to 50 ft. lbs.
- ④ Reinstall hub/drum per instructions on page 23.
- ⑤ Follow instructions on page 24 for "Completing Service".



FASTENER TORQUE WARNING

Improper brake nut torque can cause the backing plate to become detached from the brake flange causing brake failure. Reduced brake performance can lead to property damage, serious personal injury or loss of life.

Inspecting & Replacing Brake Linings

To prevent serious eye injury, always wear safety eye protection when you perform vehicle maintenance or service.



 **ASBESTOS FIBER WARNING** *Current AL-KO Axis, Inc. (“AL-KO”) and Hayes brake linings are asbestos free. Other brake linings may contain asbestos fibers, a cancer and lung disease hazard. Many brake linings contain non-asbestos fibers, whose long-term effects to health are unknown. You must use caution when you handle both asbestos and non-asbestos materials. (See page 44.)*

Follow “Service Preparation” procedures on page 13. With the trailer lifted and the hub/drum removed, inspect the linings for wear or contamination from oil or grease. Hairline heat fissures are not uncommon in bonded shoes and pose no cause for concern. If there are any questions concerning the severity of cracking, consult with an expert. If the lining is worn to 1/16" or less, or shows irregular wear or contamination from foreign substances, the shoes should be replaced with original AL-KO Axis parts.

 **WARNING** *Brake shoes should always be replaced in pairs, both brakes on the same axle. Failure to replace in pairs can result in reduced brake performance or loss of brakes which could result in property damage, serious personal injury, or loss of life.*

Inspecting & Replacing Brake Linings

Replacing Brake Linings

- ① Remove the brake shoe retract spring.

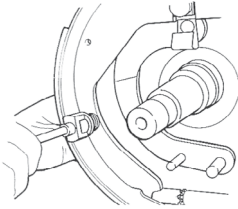

- ② Remove the shoe hold down assembly by holding the back of the pin with one hand and pushing against the spring and twisting with a hold down spring tool until the cup is released.

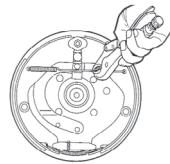

- ③ Remove both shoes together leaving the adjuster assembly and spring intact.

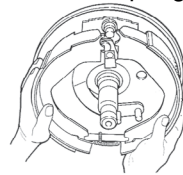

- ④ Clean the backing plate and lever arm.

- ⑤ Inspect magnet arm for any loose or worn parts.

- ⑥ Replace any spring that is broken, bent, or weak.

- ⑦ Apply a light film of Lubriplate or similar lubricant to the anchor pin and shoe rest pads & backing plate areas that are in contact with the lever arm.

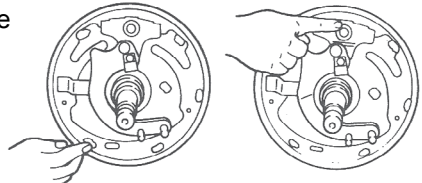

- ⑧ Attach the adjuster screw and spring to the new brake shoes. The star wheel and adjuster must be positioned as before.

- ⑨ Install the new shoes on the backing plate and reinstall shoe retract spring.



WARNING

Use only genuine AL-KO Axis, Inc. ("AL-KO") or Hayes replacement parts. Other shoes may "fit" but not function properly. Installation of non-AL-KO or non-Hayes parts could result in reduced brake performance or loss of brakes. Reduced brake performance can lead to property damage, serious personal injury, or loss of life.



FASTENER TORQUE WARNING

Torque wheel nuts after reinstalling wheel and then every fifty miles for the following 200 miles. Over or under torqued wheel nuts can cause the wheel to separate from the wheel mounting surface during operation. (See page 24 for specifications.) Wheel separation can lead to property damage, serious personal injury, or loss of life.

Inspecting & Replacing Brake Magnets

- ① Follow the procedures on page 13 for "Service Preparation".
- ② The magnet assembly can be inspected for wear while it is still assembled to the brake. Lay a straight edge over the length of the magnet face and check for flatness.

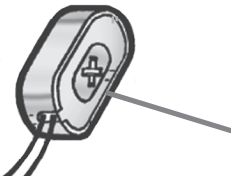
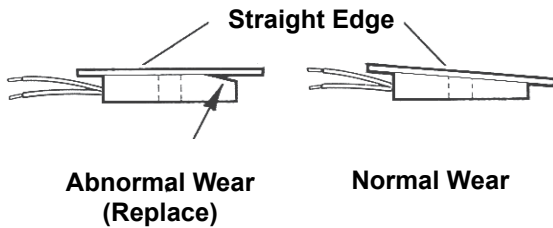

③ All AL-KO Axis, Inc. ("AL-KO") electric brakes use magnets that are similar in design. Properly functioning magnets that show normal wear may be used until copper coil is visible through the friction material in the center of the magnet.

- ④ If magnet shows abnormal wear, inspect the brake drum armature surface. The brake drum may also need to be replaced. (See page 22.)
- ⑤ If you suspect that the magnet is not functioning properly and it shows no sign of abnormal or excessive wear, check for a short circuit.

Remove the magnet from the brake as follows.

- ✓ Disconnect the magnet leads from the trailer's wiring harness and remove the strain relief, to allow the magnet leads to be pulled through the backing plate.
- ✓ Remove clips holding magnet leads to the lever arm or return spring.
- ✓ Remove clips holding magnet to lever arm and remove magnet. Keep the clips and magnet spring. Follow procedures on page 19.

Magnet Electrical Evaluation

Coil To Housing Short Circuit Test

- ① Connect one end of an ammeter (*the ammeter must have a minimum scale of 5 amps*) to either of the magnet wires. This test requires only one of the magnet leads.
- ② Connect the other end of the ammeter lead to the positive battery post.
- ③ Connect a separate piece of 16 gauge wire from the negative battery post to the magnet housing.
- ④ If the ammeter registers current, a short is indicated and the magnet must be replaced per instructions on page 19.

Note: The short may be intermittent. If there is no initial reading tap the magnet and move the leads.

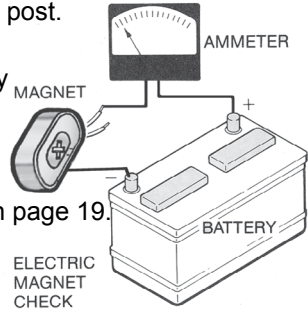

Coil Short Circuit Test

- ① Connect one magnet wire to one of the ammeter leads.
- ② Connect the other magnet wire to the negative battery post.
- ③ Connect remaining ammeter lead to positive battery post.
- ④ If the amperage reading at 12 volts is greater than 3.2 amps, the magnet should be replaced per instructions on page 19.

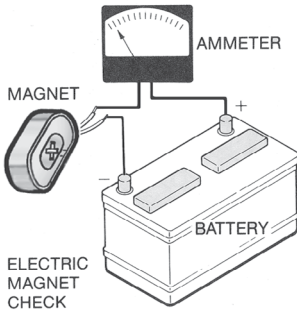

- ⑤ If the amperage reading is lower than 2.8 amps, check battery charge.

Note: The magnets must be checked as soon as power is connected. The amperage readings will drop as the temperature increases.

WARNING

Improper magnet function can result in reduced brake performance or loss of brakes. Reduced brake performance can lead to property damage, serious personal injury, or loss of life.

Replacing Brake Magnet

To prevent serious eye injury, always wear safety eye protection when you perform vehicle maintenance or service.



- ① Follow the procedures outlined on page 13 for "Service Preparation".
- ② Orient the magnet over the lever arm post such that the magnet leads are in the correct position for routing.
- ③ Push magnet over the lever arm post compressing the magnet spring between the magnet and the lever arm.
- ④ Insert the magnet clip in the slot of the magnet. Be sure to orient the magnet clip so it will "snap" into place.
- ⑤ Press down on the magnet and install the magnet clip.
- ⑥ Be sure that the magnet moves up and down freely on the lever arm post.
- ⑦ Route the wiring in the same manner noted on removal. Be sure that wires cannot bind, pinch or rub. Manually actuate lever arm to insure there is no interference.
- ⑧ Install strain relief bushing, allowing enough slack in the wiring to allow the lever arm to move without straining the wires. Be sure the wire cannot come in contact with the armature surface.
- ⑨ Connect the magnet leads to the trailer wiring harness. Reinstall hub and drum. (See page 23-24.)

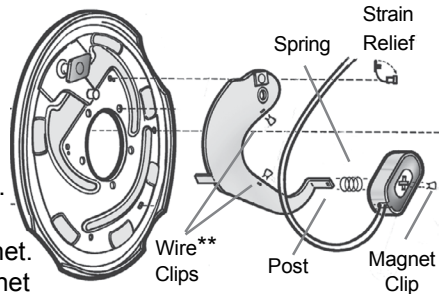

! WARNING *Road test before using. Be sure area is clear of traffic and pedestrians. Do not exceed 30 m.p.h. Follow procedures outlined by the controller manufacturer. Failure to do so could result in property damage, serious personal injury, or loss of life.*

*** Some brakes do not use wire clips. Route magnet wire with loom retaining ring, as previously installed.*

Inspecting Bearings Races & Seals

Most trailer axle bearings are unlike those in your motor vehicle in that they require periodic maintenance (see page 11) to ensure reliable, safe operation of your trailer.

- ① Follow the procedures outlined on page 13 for "Service Preparation". Refer to the schematic on pages 34-43.
- ② Wash the bearings and races with solvent cleaner to remove all old grease. Do not use compressed air or steam. They may damage components or cause components to come loose.
- ③ Check the bearings and races for worn, scored, damaged, grooved, indented, etched, spalled, gouged, nicked, corroded or otherwise damaged parts.
- ④ Check seal for nicks, tears or wear.
- ⑤ Replace damaged seals, bearings or races (see page 20-21).
Always replace bearings and races in matched sets.

ULTRALUBE® There is no need to lift the trailer before greasing axles equipped with Ultralube:

- ✓ Remove the rubber plug from grease cap.
- ✓ Insert grease gun on the grease zerk.
- ✓ Pump until new grease begins to appear.
- ✓ Replace rubber plug.

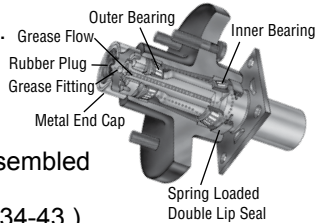

Hubs and components should also be disassembled yearly and inspected for worn or otherwise damaged parts. (See schematics on pages 34-43.)



**FASTENER TORQUE
WARNING**

Improperly torqued spindle nut can cause the hub/drum & wheel to separate from the axle resulting in property damage, serious personal injury, or loss of life.

BEARING AND SEAL REPLACEMENT CHART

AXLE CAPACITY	SPINDLE DIAMETER	INNER BEARING / CUP	OUTER BEARING / CUP	SEAL NUMBER
500 - 2,000 lbs.	1"	44643 / 44610	44643 / 44610	12192TC
2,200 lbs.	1 - 1/16"	44649 / 44610	44649 / 44610	15192TC
3,500 lbs.	1 - 1/16" - 1 - 3/8"	68149 / 68111	44649 / 44610	568861
4,400 lbs.	1 - 1/16" - 1 - 3/8"	6814 / 6811	67048 / 67010	N/A
6,000 lbs.	1 - 1/4" - 1 - 3/4"	25580 / 25520	15123 / 15245	568862*
7,000 lbs.	1 - 1/4" - 1 - 3/4"	25580 / 25520	14125 / 14276	363497**

* = 2 1/8"
** = 2 1/4"

Installing Bearings Races & Seals

To prevent serious eye injury, always wear safety eye protection when you perform vehicle maintenance or service.



Follow the procedures outlined on page 13 for "Service Preparation".

Install Races

Always replace bearings and races as a set. Install races (*new hub/drums should have races already installed*) using a mild steel drift or bar. Do not use hardened steel or brass bars as they may damage, chip or leave deposits on the races. Final setting of the race against the shoulder should be checked with feeler gauges and be within 0.002" of the shoulder in the hub/drum.

Pack Bearings

Prior to repacking bearings, all grease must be removed from the hub/drum and bearings. Bearings should be packed by machine or by hand methods to insure that grease is forced into the cavities between the rollers, cone and cage of the bearings. For axles equipped with Ultrulube refer to page 20.

Grease

Use a high temperature, automotive type wheel bearing grease produced by a reputable manufacturer. The soap type should be lithium complex or equivalent. Use NLGI Grade 2 product with a minimum dropping point of 440° F.

Installing Seals

It is recommended to install a new seal after removing the hub/drum. Be sure that the inner race and fully packed inner bearing are installed. Use the correct size seal driver. If this is not available, use a clean block of wood which is large enough to cover the entire seal. Tap block to seat seal.



WARNING

Improper seal or bearing installation or adjustment or insufficient maintenance can lead to wheel bearing failure which could cause the hub/drum and wheel to separate from the axle during operation resulting in property damage, serious personal injury, or loss of life.

Brake Drum

Inspecting The Brake Drum

Follow the procedures outlined on page 13 for "Service Preparation".

Check the armature surface for excessive galling due to severe contamination (mud, stones, etc.). One or two light score marks are not cause for resurfacing or replacing the brake drum. Under normal conditions, the armature surface should last indefinitely.

Inspect the drum's shoe surface. This surface should have a dull gray appearance and be free from heavy scoring and/or excessive wear. One or two light score marks are not cause for resurfacing or replacing the brake drum. If there are any questions concerning the condition of a drum, consult an expert. Drums heavily scored, worn to more than 0.020" oversize, or with 0.015" runout should be replaced or resurfaced. Do not exceed the maximum diameter cast in the brake drum.



WARNING

Heavily scored, worn or oversized drums can result in reduced brake performance or loss of brakes. This could result in property damage, serious personal injury, or loss of life.

Resurfacing The Brake Drum

A standard drum lathe may be used to machine the shoe surface. Do not exceed the maximum diameter cast into the brake drum. The drum should be replaced if it must be bored more than the maximum diameter cast in the brake drum.

Armature surface machining is a difficult process with most drum lathes and is not recommended. If it is resurfaced it should be machined to a 120 micro inch finish and must have 0.060" above the stud heads. Do not remove more than 0.030" of material.

Be sure to remove any metallic chips and contamination resulting from drum machining.



WARNING

Failure to remove chips could cause bearing failure which could cause the hub/drum and wheel to separate from the axle. This could result in property damage, serious personal injury, or loss of life.

Reinstall races per instructions on page 20-21. Replacement or new hub/drums should have races already installed.

Installing Brake Drum

Note: When installing a new or resurfaced drum be sure to use new brake shoes and magnets.

DANGER
SAFETY GLASSES
REQUIRED

- ① Install packed inner bearing and seal in hub/drums. (See page 22-21.)
- ② Slide hub/drum onto spindle taking care not to damage spindle bearing or seal. Press until inner bearing stops against the inner bearing journal.

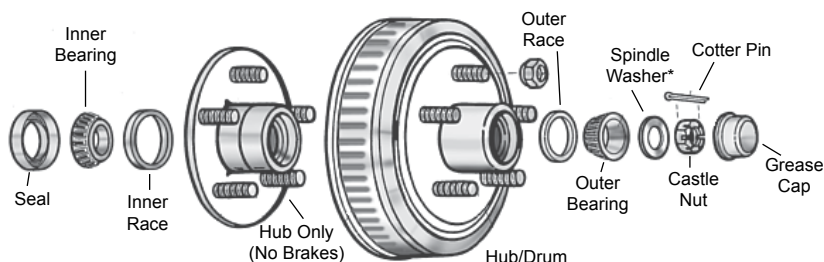

- ③ Install packed outer bearing.
- * ④ Re-install washer when required (see pgs. 32-40).

Bearing Adjustment

- ① To get the proper "feel" for bearing clearance, the spindle nut must turn freely on the spindle and the brake must be readjusted so that there is no drag on the drum.
- ② While slowly turning the hub/drum tighten the spindle nut to approximately 20 ft/lbs then loosen. This is especially important if new bearing races have been installed.
- ③ With drum stationary (do not rotate), retighten the spindle nut to 7 ft/lbs (zero clearance) then back off one slot (0.001"-0.010" end play) and align cotter pin hole. Insert cotter pin and bend both ends both ends over end of spindle. Install grease cap.





WARNING

Improper bearing adjustment can lead to wheel bearing failure which could cause the hub/drum and wheel to separate from the axle during operation. This could result in property damage, serious personal injury, or loss of life.

Completing Service

- ① Be sure that all components have been properly installed.
- ② Adjust the brakes (page 14). For new brakes, shoes, drums, or magnets, follow break in procedure (pg. 11).
- ③ Check brake function while trailer is still raised. Connect trailer wiring to tow vehicle and apply brake. The trailer brakes should activate and prevent the hub/drum from turning. Repeat for all brakes.
- ④ Install the wheels.

 **WARNING** *When installing wheels other than those originally installed on the trailer, see the “Wheel Compatibility” warning on page 39. Installation of incorrect wheel could cause wheel separation which could result in property damage, serious personal injury, or loss of life.*

 **FASTENER TORQUE WARNING** *It is important to maintain proper torque to provide safe and secure attachment of the wheel to the hub/drum. Be sure to use wheel nuts that are compatible with the coin in the wheel. Improperly torqued wheel nuts can cause the wheel to separate from the wheel mounting surface during operation. This could result in property damage, serious personal injury, or loss of life.*

- ⑤ Start all lug nuts by hand to prevent cross threading.
- ⑥ Wheel nut torque requirements vary depending on the size and manufacturer of the wheel. Always use the wheel manufacturer’s recommendation but do not exceed 120 ft/lbs on 1/2" studs. Never exceed wheel manufacturer’s recommendations.
- ⑦ **Tighten each lug nut in the order shown to the torque shown in the chart.**

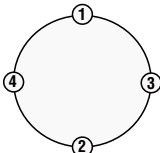

4 Lug Bolt Pattern

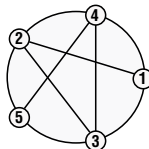

5 Lug Bolt Pattern

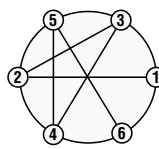

6 Lug Bolt Pattern

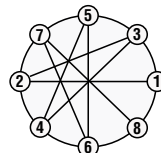

8 Lug Bolt Pattern

- ⑧ Lower trailer and stow jacks, jack stands and auxillary blocking.

 **WARNING** *Road test before using. Be sure area is clear of traffic and pedestrians. Do not exceed 30 m.p.h. Follow procedures outlined by the controller manufacturer. Failure to do so could result in property damage, serious personal injury, or loss of life.*

Tire Inspection



WARNING

When replacing tires consult wheel and tire manufacturers' specifications for compatibility. Improperly matched wheels and tires may fail and cause property damage, serious personal injury, or loss of life. See "Wheel Compatibility" warning on page 26.

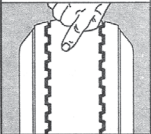
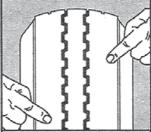
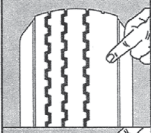
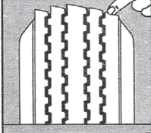
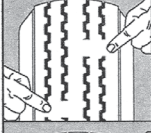
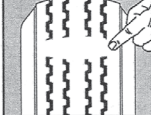
	Condition	Possible Cause	Remedy
	Even Center Wear	Over Inflation	Check & Adjust Pressure When Cold
	Inside & Outside Wear	Under Inflation	Check & Adjust Pressure When Cold
	Smooth, Side Wear - One Side	Loss of Camber or Overloading	Check & Unload As Necessary Have Alignment Checked
	"Feathering" Across The Face	Axle Not Square To Frame or Incorrect Toe In	Square Axles Have Alignment Checked
	Cupping	Loose Bearings or Wheel Balance	Check Bearing Adjustment and Wheel & Tire Balance
	Flat Spots	Wheel Lockup	Adjust Brakes

WHEEL TORQUE REQUIREMENTS

Wheel Size	1st Stage	Torque Sequence 2nd Stage	3rd Stage
12"	20 - 25	35 - 40	50 - 75
13"	20 - 25	25 - 40	50 - 75
14"	20 - 25	50 - 60	90 - 120
15"	20 - 25	50 - 60	90 - 120
16"	20 - 25	50 - 60	90 - 120

Wheel Compatibility

 **WARNING** *Be sure to read and understand the following information before installing wheels. Installation of wheels which are not compatible with the axle assembly could result in wheel separation which can lead to property damage, serious personal injury, or loss of life.*

AL-KO Axis, Inc. (“AL-KO”) Corporation manufactures hubs and drums that are compatible with many wheels used in the trailer industry that have matching bolt patterns. AL-KO does not manufacture wheels, nor do they recommend a specific wheel for compatibility with the hubs and drums they manufacture. The wheel manufacturer should be contacted for proof of compatibility before use.

Customers using wheels which have not been tested for compatibility, must do so to insure they are compatible with AL-KO hubs and drums. Elements of compatibility include but are not limited to:

- ✓ Diameter of the hub mounting surface.
- ✓ Stud length and diameter.
- ✓ Location and number of studs.
- ✓ Center hole diameter for the wheel.
- ✓ Wheel mounting offset from the rim center.
- ✓ Rated capacity of the wheel.
- ✓ Wheel fastener torque.
- ✓ Wheel nut size and shape.
- ✓ Impact of the use of any wheel accessories (such as decorative center caps) that could affect the proper seating of the wheel to the hub surface.

A cornering fatigue test based on SAE J1095/SAE J267 and field tests are recommended for all wheels and rims to be installed on AL-KO hubs and drums. These tests require special expertise and equipment. Persons without such equipment or expertise should contact the wheel manufacturer to verify that a wheel is compatible with the AL-KO hubs and drums. AL-KO is not responsible for wheels or rims that are installed on their hubs or drums.

Troubleshooting

The most common reason for poor brake performance is improper brake adjustment. The first step in correcting brake problems is to adjust the brakes. (See page 14.) This standard maintenance should be performed according to the schedule on page 11.

The second most common problem is faulty, improperly installed or improperly used wiring or electrical components. These components are not supplied or installed by AL-KO Axis, Inc. but can greatly affect the performance of the brakes.

If **none of the brakes** are working, they probably have no power. If **all of the brakes** experience the same problem it is probably caused by an improper signal to the brakes. Possible causes include operator error, improper synchronization, faulty controller or break-away switch and any wiring or circuit problem. The first step in isolating brake problems is to identify the amount of power going to the brakes.

System voltage is measured at the magnets by connecting a volt meter to the magnet lead wires. Connect the trailer wire connector to the tow vehicle. The engine of the tow vehicle should be running. The voltage should start at 0 volts. As the controller bar is slowly actuated, it should **gradually** increase to about 12 volts. If the increase is not gradual the brakes would apply instantaneously. The lower the threshold voltage the smoother the brakes will apply.

System amperage is the amperage being drawn by all brakes on the trailer. Single magnet amperage can be measured with an ammeter attached at the magnet lead wires. Follow procedure above. Each magnet should draw about 3 amps at 12 volts. To check the total system the controller output to the brakes must be disconnected and the ammeter put into series in the circuit. With magnets cold (70° F), the ammeter should read about 3 amps for each brake or 12 amps for a tandem axle trailer (4 brakes). (Amperage is affected by the length and gauge of wire between ammeter and brake as well as between the power source and brakes.)

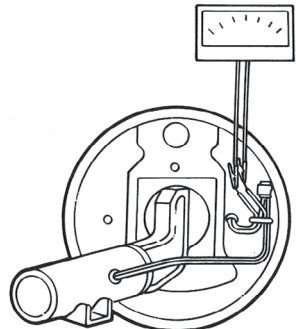

Use either alligator clips or volt/ohm meter probes



Avoid working in wet conditions. Although you are not likely to get seriously shocked by 12 volt D.C. current, it can create a spark and ignite anything flammable.

Troubleshooting

Many brake problems result from faulty wiring or a faulty component in the circuit. AL-KO Axis, Inc. does not supply or install these components. For electrical problem assistance contact the trailer manufacturer, dealer or component (eg. brake controller) manufacturer.

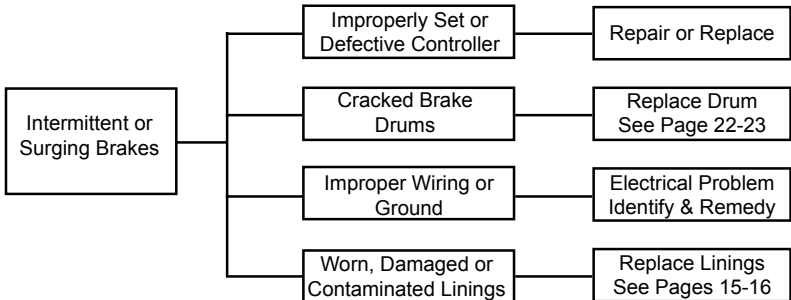
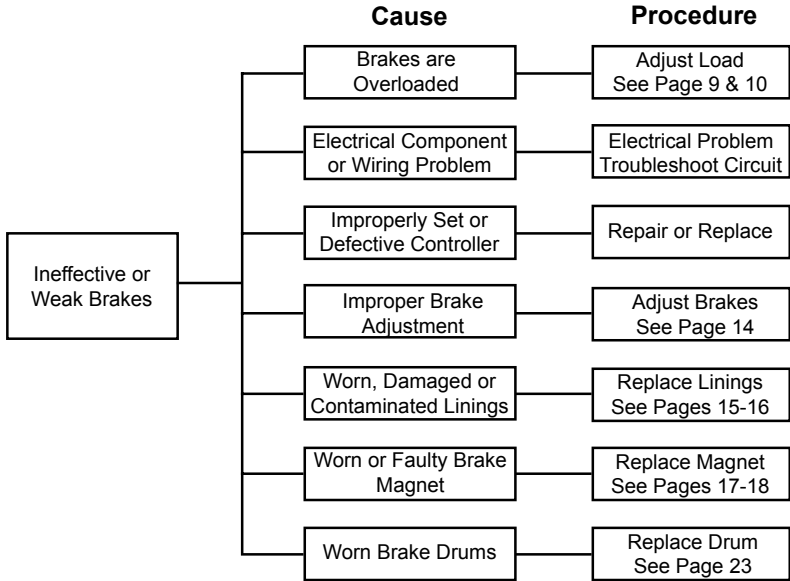

Troubleshooting

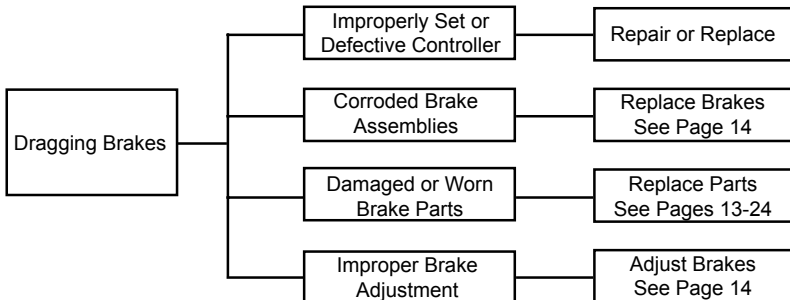
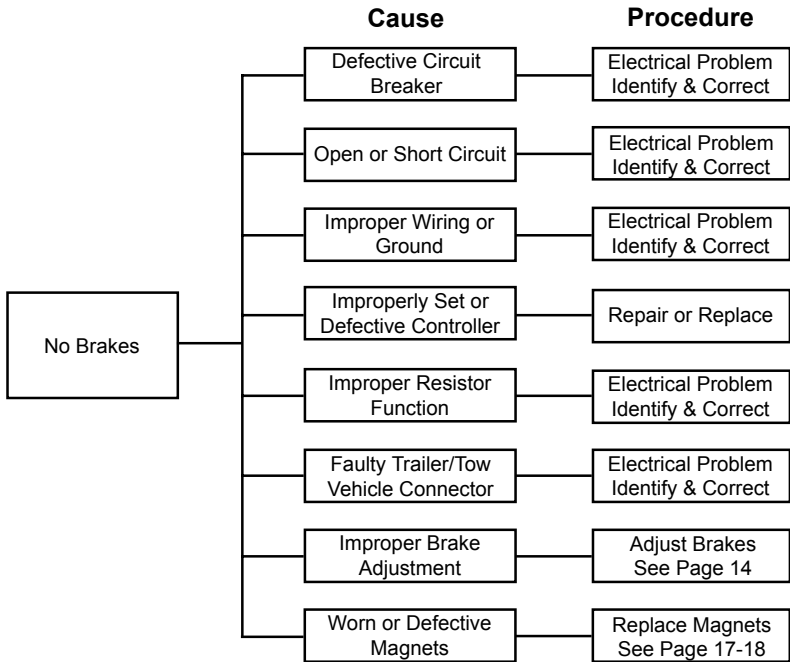

Troubleshooting

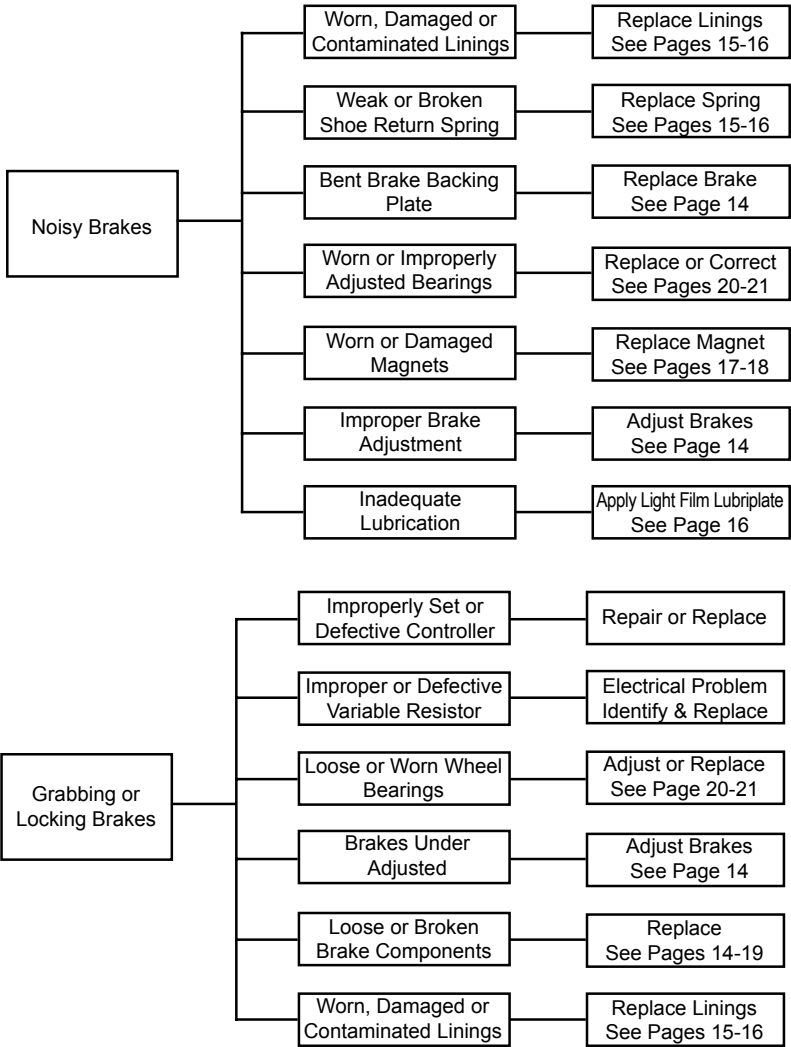

Leaf Spring Suspension

All suspension components should be visually inspected at least every 12,000 miles or 12 months. Check for loose fasteners and torque to proper values.



FASTENER TORQUE WARNING

Improper torque can cause component failure and the axles to become detached from the frame. This could result in property damage, serious personal injury, or loss of life.



WARNING

See "Lifting Trailer" instructions on page 13. Failure to adhere to these instructions could result in property damage, serious personal injury, or loss of life.

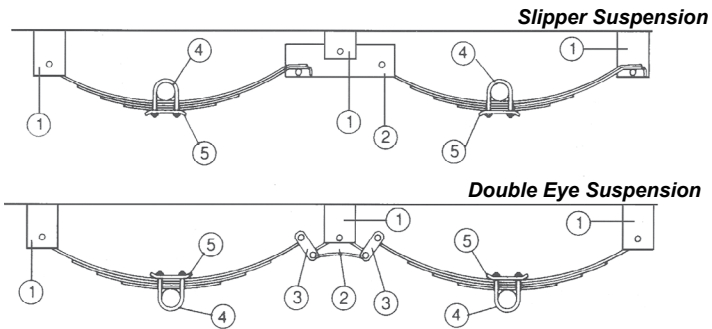

- ① Spring Hanger ② Equalizer ③ Shackle Link ④ U-Bolt ⑤ Tie Plate

TORQUE VALUES		
Description	Torque (Ft. Lbs.)	
	MINIMUM	MAXIMUM
3/8" U - Bolt	30	40
1/2" U - Bolt	45	60
Spring Eye Bolt Shackle Bolt Equalizer Bolt	Parts must be able to rotate freely. Tighten to snug fit only.	
Shoulder Bolt	30	50

- ① Follow the procedures outlined on page 13 for "Service Preparation".
- ② Place suitable blocks under the axle beam. The blocks are only to support the axle weight once components are disconnected. Frame must be supported as outlined in "Service Preparation" on page 13.
- ③ Disassemble the U-Bolts, nuts and tie plates and rest the axle assembly on the blocks.
- ④ Replace axle, springs, spring eye bushings, shackle links, equalizers and /or fasteners as required.
- ⑤ Reinstall repaired or replaced parts using proper torque values.
- ⑥ Although routine lubrication is not required, pivotal suspension points may be greased if desired.

Rubber Torsion Suspension

AL-KO Axis, Inc. ("AL-KO") rubber suspension axle utilizes three rubber cords on each side of the axle assembly. They are encased under pressure between a hexagonal outer tube and a triangular inner tube. A trailing arm (must be mounted as shown) is welded to each inner tube. As the axle operates, the arm swings up and down, thus rolling the rubber.

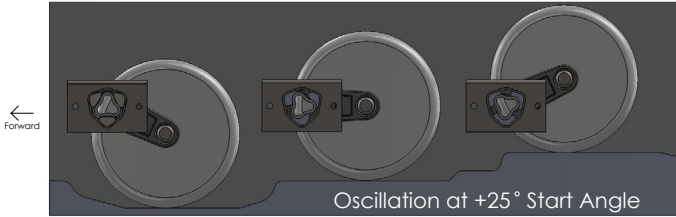

The position of the trailing arm varies depending on the starting angle. Three common start angles (+25 , 0 , and -20) are shown below.

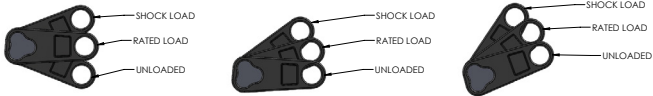

Depending on part number or the starting angle (with no weight on axle) will determine the suspensions terminology for down/up or plug negative. For more clarification please call 574-294-6651.

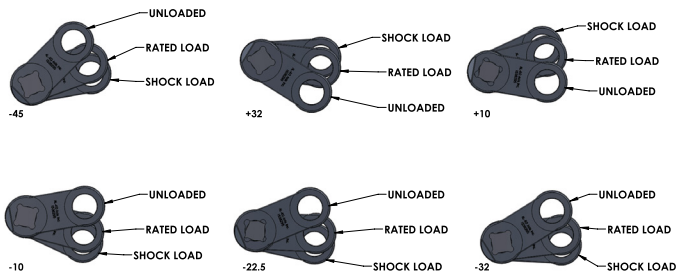

Rubber Torsion Suspension

When used properly, the AL-KO Axis, Inc rubber torsion suspension requires no maintenance and will provide years of reliable and uninterrupted service. (Abuse such as overloading or impact will greatly reduce axle life.) Brakes and hub/drum assemblies must be serviced according to the schedule on page 11.

Some rubber torsion axles may be welded to the frame. Axle mounted with bolts should be checked at least every 12,000 miles or 12 months and the bolts torqued to proper values. Bolts may be located in the top or side of the axle mounting bracket (see below).

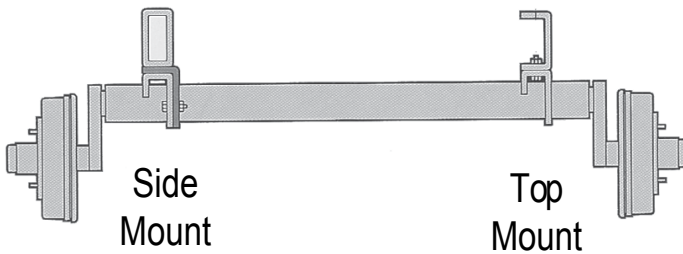

Description	Torque (Ft. Lbs.)	
	Minimum	Maximum
1/2" Bolt	110	120
5/8" Bolt	145	155



Use a torque wrench to set these values. Improper torque can cause component failure which could result in property damage, serious personal injury, or loss of life.

Service Replacement Parts

7" Hub/Drum

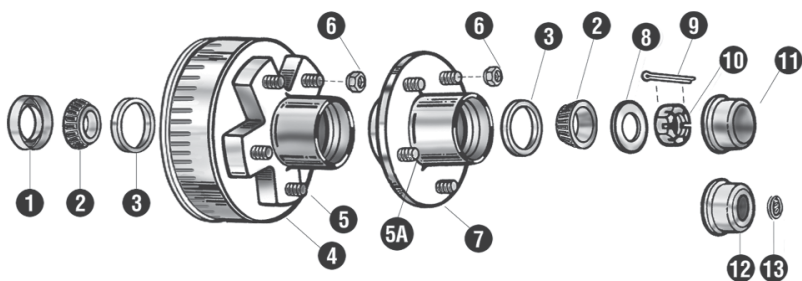

Parts List

No.	Brake Part Description	AL-KO Axis, Inc.*	Hayes Part No.
1	Grease Seal Double Lipped	568886	—
2	Bearing Cone (Inner & Outer) 44649	363180	093706
3	Bearing Cup (Inner & Outer) L44610	363913	093707
4	7" Hub & Drum, Cupped & Studded	—	—
4A	4 on 4.0" Bolt Circle	363215	—
4B	5 on 4.5" Bolt Circle	363216	09080220
5	Stud, 1/2" - 20 x 1.81 Long Knurl	363907	09251525
5A	Stud, 1/2" - 20 x 1.81 Short Knurl	363908	09251510
6	Wheel Nut 1/2" - 20 60° Cone	363203	090608
7	BT Idler Hub, Cupped & Studded	—	—
7A	4 on 4.0" Bolt Circle	363185	09080388
7B	5 on 4.5" Bolt Circle	363188	09080398
7C	5 on 4.5" Bolt Circle (Wide Flange)	363190	09080408
8	Spindle Washer 1" x 1 3/4" O.D.	363259	090509
9	Cotter Pin	363258	091901
10	Spindle Nut 1" - 14	363257	090601
11	Grease Cap	363182	092102
12	Grease Cap (UL)	363277	09210101
13	Rubber Plug (UL)	568067	09213611

* Contact Customer Service 574-294-6651 for Import / Cross Reference / Domestic Part Numbers.

Service Replacement Parts

7" x 1 1/4" Electric Brake

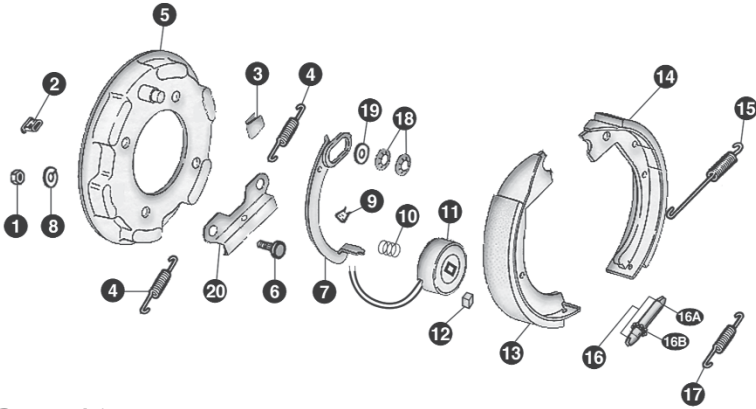

Parts List

No.	Brake Part Description	AL-KO Axis Inc.*	Hayes Part No.
0	RH Brake Assembly Complete	623763	09230201
0	LH Brake Assembly Complete (Shown)	623762	09230202
1	Brake Mounting Nut 7/16" - 20	363312	090616
2	Plug Adjuster Slot	606367	—
3	Shoe Hold Down Clip	606366	—
4	Shoe Centering Spring	606380	—
5	Backing Plate Assembly	N/A	—
6	Brake Mounting Stud (7/16" - 20)	606360	—
7	RH Lever Assembly	623754	—
7	LH Lever Assembly (Shown)	623753	—
8	Brake Lockwasher 7/16"	363335	—
9	Clip, Wire	606373	—
10	Magnet Spring	606381	—
11	Magnet Assembly	623752	—
12	Clip, Magnet	606358	—
13	Primary Shoe & Lining (Shown)	623757	—
14	Secondary Shoe & Lining	623758	—
15	Shoe Retractor Spring	606382	—
16	Adjuster Screw Assembly	606357	—
16A	Adjuster Screw Socket	606364	—
16B	7" Adjuster Nut	606356	—
17	Adjuster Screw Spring	606374	—
18	Clip, Anchor Pin/Lever	606372	—
19	7" Brake Washer	700140	—
20	Support Plate 7" Electric Brake	606369	—

* Contact Customer Service 574-294-6651 for Import / Cross Reference / Domestic Part Numbers.

Service Replacement Parts

10" x 1³/₄" Drum

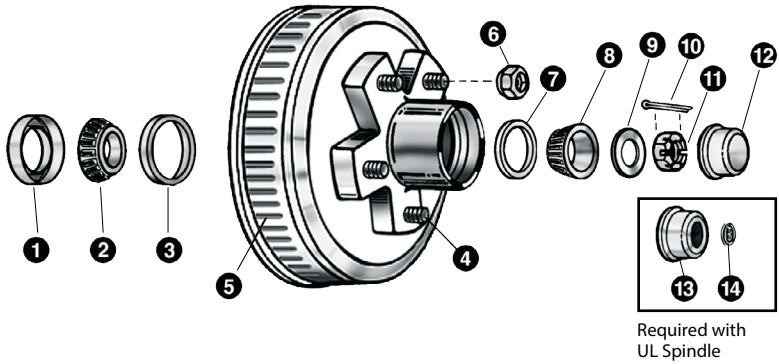

Parts List

No.	Brake Part Description	AL-KO Axis, Inc.	Hayes Part No.
1	Grease Seal Double Lipped	568861	09103305
2	Inner Bearing Cone 68149	363192	093705
3	Inner Bearing Cup L68111	363914	093718
4	Stud 1/2" - 20 x 2	1530092	—
5	Hub & Drum/Cups & Studs	—	—
5A	5 on 4.5" Bolt Circle	1530189	—
5B	5 on 5.0" Bolt Circle	1530190	—
6	Wheel Nut, 1/2" - 20 60° Cone	363203	090608
7	Outer Bearing Cup L44610	363913	093707
8	Outer Bearing Cone 44649	363180	093706
9	Spindle Washer 1" x 1 ³ / ₄ " OD	363259	090509
10	Cotter Pin	363258	091901
11	Spindle Nut 1" -14	363257	09060101
12	Grease Cap	363182	092102
13	Grease Cap (UL)	363277	09210104
14	Rubber Plug (UL)	568067	09213611

Service Replacement Parts

10" x 13/4" Electric Brake

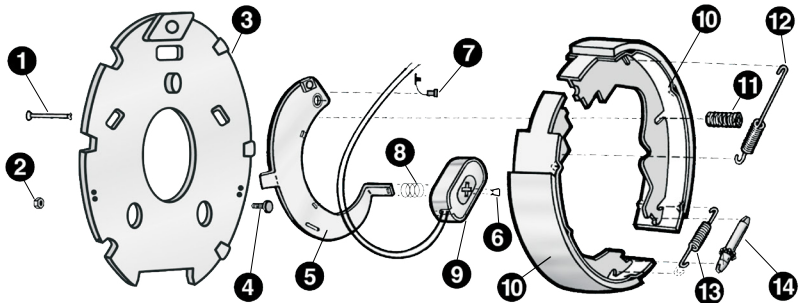

Parts List

No.	Brake Part Description	AL-KO Axis, Inc.	Hayes Part No.
0	RH Brake Assembly Complete	1530116	—
0	LH Brake Assembly Complete (Shown)	1530117	—
1	Shoe Hold Down Pin	5785	—
2	Brake Mounting Nut 7/16" - 20	363312	090616
3	Backing Plate Assembly	5050	—
4	Brake Mounting Stud (7/16" - 20)	1530112	—
5	RH Lever Assembly	568121	60283001
5B	LH Lever Assembly (Shown)	568122	60282901
6	Clip, Wire & Magnet	568092	09680815
7	Strain Relief (Magnet Wire)	568090	—
8	Magnet Spring	568103	096522
9	Magnet Assembly (Green Wire)	568119	—
10	Primary Shoe & Lining	1530114	—
11	Shoe Hold Down Cup & Spring	568093	10443
12	Shoe Retract Spring	568097	09650603
13	Adjuster Screw Spring	568095	096526
14	Adjuster Screw Assembly	568110	60272401
14B	Adjuster Screw Socket	568086	60272801
	Magnet Wire Loom (Not Shown)	1531153	—

Service Replacement Parts 10" Hub/Drum

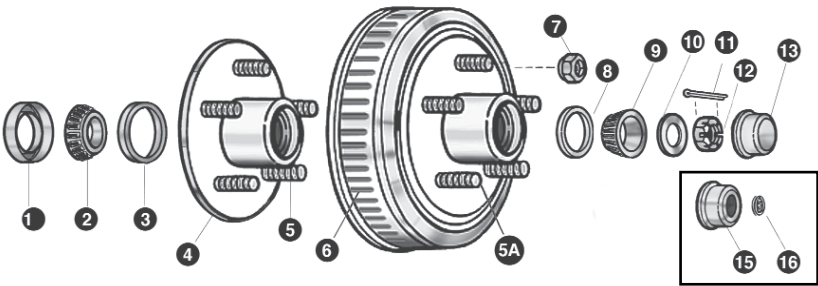

Required with
UL Spindle

Parts List

No.	Brake Part Description	AL-KO Axis, Inc.*	Hayes Part No.
1	Grease Seal Double Lipped	568861	09103305
2	Inner Bearing Cone 68149	363192	093705
3	Inner Bearing Cup L68111	363914	093718
4	Idler Hub w/Cups & Studs	—	—
4A	5 on 4.5" Bolt Circle	363191	09089137
4B	5 on 4.75" Bolt Circle	363821	09080438
4C	5 on 5.0" Bolt Circle	363194	09080377
4D	5 on 5.5" Bolt Circle	363228	09080347
4E	6 on 5.5" Bolt Circle	363195	09080357
5	Stud 1/2" - 20 x 1.81 Short Knurl	363908	09251510
5A	Stud 1/2" - 20 x 1.81 Long Knurl	363907	09251525
6	Hub & Drum/Cups & Studs	—	—
6A	5 on 4.5" Bolt Circle	363219	09080607
6B	5 on 4.75" Bolt Circle	363630	09080428
6C	5 on 5.0" Bolt Circle	363220	09080257
6D	5 on 5.5" Bolt Circle	363221	09080327
6E	6 on 5.5" Bolt Circle	363222	09080367
7	Wheel Nut, 1/2" - 20 60° Cone	363203	090608
8	Outer Bearing Cup L44610	363913	093707
9	Outer Bearing Cone 44649	363180	093706
10	Spindle Washer 1" x 1 3/4" OD	363259	090509
11	Cotter Pin	363258	091901
12	Spindle Nut 1" - 14	363257	09060101
13	Grease Cap	363182	092102
15	Grease Cap (UL)	363277	09210101
16	Rubber Plug (UL)	568067	09213611

* Contact Customer Service 574-294-6651 for Import / Cross Reference / Domestic Part Numbers.

Service Replacement Parts

10" x 2 1/4" Electric Brake

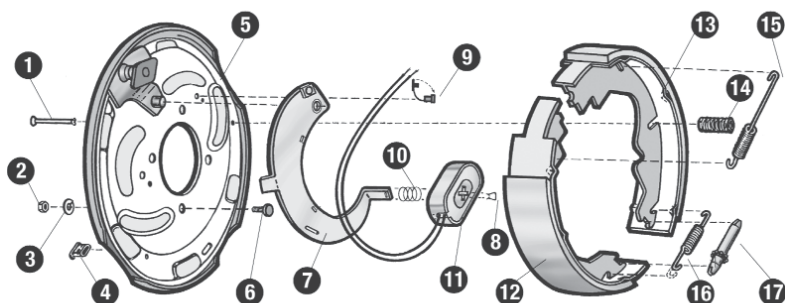

Parts List

No.	Brake Part Description	AL-KO Axis, Inc.*	Hayes Part No.
0	RH Brake Assembly Complete	363383.1	60202703
0	LH Brake Assembly Complete (Shown)	363383.2	60202803
1	Shoe Hold Down Pin	568094	09661104
2	Brake Mounting Nut 7/16" - 20	363312	090616
3	Brake Lockwasher 7/16"	363335	—
4	Plug, Adjuster Slot	568089	096932
5	Backing Plate Assembly	—	—
6	Brake Mounting Stud (7/16" - 20)	363900	090762
7	RH Lever Assembly	568121	60283001
7	LH Lever Assembly (Shown)	568122	60282901
8	Clip, Wire & Magnet	568092	09680815
9	Strain Relief (Magnet Wire)	568090	092715
10	Magnet Spring	568103	096522
11	Magnet Assembly (White Wire)	K568111	ML44
12	Primary Shoe & Lining	K568112	SL110
12	Primary Shoe & Lining (Parking Brake)	568173	—
13	Secondary Shoe & Lining	K568112	SL110
13	Secondary Shoe & Lining (Parking Brake)	568174	—
14	Shoe Hold Down Spring	568093	10443
15	Shoe Retract Spring	568097	09650603
16	Adjuster Screw Spring	568095	096526
17	Adjuster Screw Assembly	568110	60272401
17	Adjuster Screw Socket	568086	60272801

* Contact Customer Service 574-294-6651 for Import / Cross Reference / Domestic Part Numbers.

Service Replacement Parts

10" Hub/Drum T44/D44

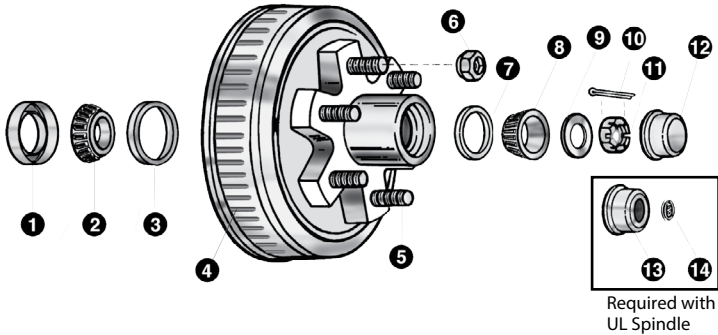

Parts List

No.	Brake Part Description	AL-KO Axis, Inc.	Hayes Part No.
1	Grease Seal Double Lipped	568861	568861
2	Inner Bearing Cone 68149	363192	093705
3	Inner Bearing Cup L68111	363914	093718
4	Hub & Drum w/Cups & Studs 6 on 5.5" Bolt Circle	— 568955	—
5	Stud 1/2" - 20 x 1.81 Long Knurl	363907	09251525
6	Wheel Nut, 1/2" - 20 60° Cone	363203	090608
7	Outer Bearing Cup LM67010	363912	093702
8	Outer Bearing Cone LM67048	—	093704
9	Spindle Washer 1" x 1 3/4" OD	363259	090509
10	Cotter Pin	363258	091901
11	Spindle Nut 1" -14	363257	09060101
12	Grease Cap	363182	092102
13	Grease Cap (UL)	363277	09210101
14	Rubber Plug (UL)	568067	09213611

Service Replacement Parts

10" x 2 1/4" Electric Brake T44/D44

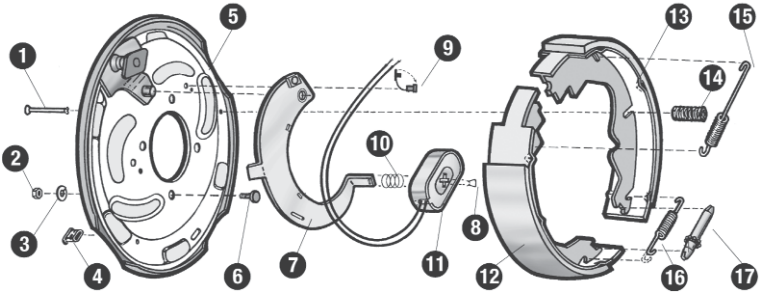

Parts List

No.	Brake Part Description	AL-KO Axis, Inc.	Hayes Part No.
0	RH Brake Assembly Complete	6239	—
0	LH Brake Assembly Complete (Shown)	6240	—
1	Shoe Hold Down Pin	568094	09661104
2	Brake Mounting Nut 7/16" - 20	363312	090616
3	Brake Lockwasher 7/16"	363335	—
4	Plug, Adjuster Slot	568089	096932
5	Backing Plate Assembly	—	—
6	Brake Mounting Stud (7/16" - 20)	363900	090762
7	RH Lever Assembly	568121	60283001
7	LH Lever Assembly (Shown)	568122	60282901
8	Clip, Wire & Magnet	568092	09680815
9	Strain Relief (Magnet Wire)	568090	—
10	Magnet Spring	568103	096522
11	Magnet Assembly (White Wire)	K568111	—
12	Primary Shoe & Lining	—	—
13	Secondary Shoe & Lining	—	—
14	Shoe Hold Down Spring	568093	10443
15	Shoe Retract Spring	568097	09650603
16	Adjuster Screw Spring	568095	096526
17	Adjuster Screw Assembly	568110	60272401
17	Adjuster Screw Socket	568086	60272801

Service Replacement Parts 12" Hub/Drum

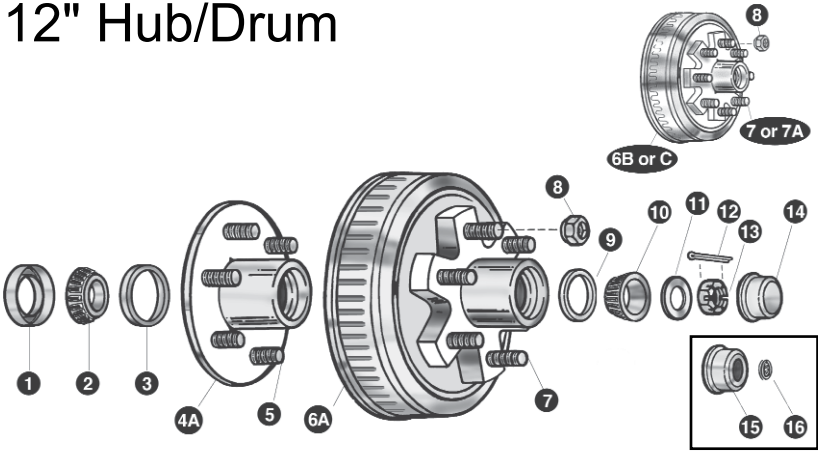

Required with
UL Spindle

Parts List

No.	Brake Part Description	AL-KO Axis, Inc.	Hayes Part No.
1	Grease Seal Double Lip 2 ¹ / ₄ " Shaft (prior to 1997)	363497	09103304
1	Grease Seal Double Lip 2 ¹ / ₈ " Shaft	568862	09103304L
2	Inner Bearing Cone 25580	363196	093703
3	Inner Bearing Cup 25520	363911	093701
4	Idler Hubs w/ Cups & Studs	—	—
4A	6 on 5.5" Bolt Circle	363200	09080134
4B	8 on 6.5" Bolt Circle	363902	09080448
5	Stud 1/2" - 20 x 1.81 Long Knurl	363907	09251525
6	Hub & Drum w/Cups & Studs	—	—
6A	6 on 5.5" Bolt Circle (for 15123)	363239	09084604
6B	8 on 6.5" Bolt Circle (for 14125A)	363236	09089264
6C	8 on 6.5" Bolt Circle (for 14125A) 9/16"	568182	09089324
7	Stud 1/2" - 20 x 2.50 Long Knurl	363909	09251512
7A	Stud 9/16" - 18 x 2.50 Long Knurl	363906	09251100
8	Wheel Nut, 1/2" - 20 60° Cone	363203	090608
8	Wheel Nut, 9/16" - 18 60° Cone	363895	090640
9	Outer Bearing Cup (15245) for 6 on 5.5" BC	363916	093725
9	Outer Bearing Cup (14276) for 8 on 6.5" BC	363915	093719
10A	Outer Bearing Cone (15123) for 6 on 5.5" BC	363420	093709
10	Outer Bearing Cone (14125A) for 8 on 6.5" BC	363397	093720
11	Spindle Washer 1" x 2" OD	568326	09050901
12	Cotter Pin	363528	091901
13	Spindle Nut 1" - 14	363257	09060101
14	Grease Cap for 15123 Bearing	363199	092101
14	Grease Cap for 14125A Bearing	363419	092110
15	Grease Cap for 15123 Bearing (UL)	363496	09210102
15	Grease Cap for 14125A Bearing (UL)	363775	09210103
16	Rubber Plug (UL)	568067	09213611

* Contact Customer Service 574-294-6651 for Import / Cross Reference / Domestic Part Numbers.

Service Replacement Parts

12" x 2" Electric Brake

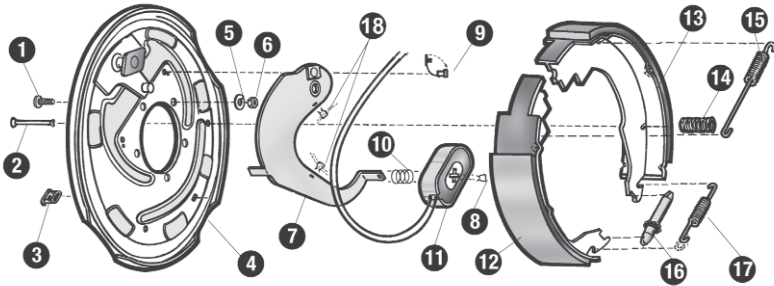

Parts List

No.	Brake Part Description	AL-KO Axis, Inc.*	Hayes Part No.
0	RH Brake Assembly Complete	363233.1	60208712
0	LH Brake Assembly Complete (Shown)	363233.2	60208713
1	Brake Mounting Stud $\frac{3}{8}$ " - 24	363989	090761
2	Shoe Hold Down Pin	568094	09661106
3	Plug Adjuster Slot	568089	096932
4	Backing Plate Assembly	—	—
5	Brake Lock Washer $\frac{3}{8}$ "	363334	090532
6	Brake Mounting Nut $\frac{3}{8}$ " - 24	363333	090625
7	RH Lever Assembly	568113	60283200
7	LH Lever Assembly (Shown)	568114	60283100
8	Clip, Wire & Magnet	568092	09680815
9	Strain Relief, Wire	568090	—
10	Magnet Spring	568103	096522
11	Magnet Assembly (White Wire)	K568111	M144
12	Primary Shoe & Lining	K568126	SL126B
13	Secondary Shoe & Lining	K568126	SL126B
14	Shoe Hold Down Spring	568093	10443
15	Shoe Retract Spring	568096	096527
16	Adjuster Screw Assembly	568110	60272401
16	Adjuster Screw Socket	568086	60272801
17	Adjuster Screw Spring	568095	096526
18	Clip, Wire Retainer	568183	—

* Contact Customer Service 574-294-6651 for Import / Cross Reference / Domestic Part Numbers.

Asbestos and Non-Asbestos Fiber Warning



Contact OSHA for details concerning the dangers and proper handling of asbestos and non-asbestos fibers.

Contact OSHA for procedures to reduce exposure to asbestos fiber dust, a cancer and lung disease hazard. Because some brake linings contain asbestos, workers who service brakes must understand the potential hazards of asbestos and precautions for reducing risks. Exposure to airborne asbestos dust can cause serious and possibly fatal diseases, including asbestosis (a chronic lung disease) and cancer, principally lung cancer and mesothelioma (a cancer of the lining of the chest or abdominal cavities). Some studies show that the risk of lung cancer among persons who smoke and who are exposed to asbestos is much greater than the risk for non-smokers. Symptoms of these diseases may not become apparent for fifteen or more years after the first exposure to asbestos.

Workers must use caution to avoid creating and breathing dust when servicing brakes. **Specific recommended work practices for reducing exposure to asbestos should be obtained from OSHA.** Consult your employer for more details.

Following is a partial list of procedures that may apply.

Separate Work Areas. Whenever feasible, service brakes in a separate area away from other operations to reduce risks to unprotected persons.

Respiratory Protection. Wear a respirator equipped with a high-efficiency (HEPA) filter approved by NIOSH or MSHA for use with asbestos at all times when servicing brakes.

Compressed Air. Never use compressed air by itself, dry brushing, or a vacuum not equipped with HEPA filter when cleaning brake parts or assemblies.

Worker Clean-Up. After servicing brakes, wash your hands before you eat, drink or smoke. Shower after work. Do not wear work clothes home. Use a vacuum equipped with HEPA filter to vacuum work clothes after they are worn. Launder them separately. Do not shake or use compressed air to remove dust from work clothes.

Waste Disposal. Dispose of discarded linings, used rags, cloths and HEPA filters with care such as in clear plastic bags. Consult applicable EPA, state and local regulations on waste disposal.

LIMITED WARRANTY



AL-KO Axis, Inc. ("AL-KO") warrants to the original purchaser of its axles ("AL-KO'S Customer") that the axle assembly (torsion or spring) will be free from substantial defects in material and workmanship for a period of two (2) years from the date of the first retail sale of the product on which the axles are installed (the "2 year Warranty Period"), with the following exception; in place of the 2 year Warranty Period, rubber suspension axles manufactured by AL-KO are warranted as provided herein for a period of five (5) years from the date of the first retail sale of the product on which the axles are installed (the "5 year Warranty Period") (collectively the "Warranty Period"). This Limited Warranty extends only to the original installation of AL-KO's axles and is not transferable.

DISCLAIMER: THIS WARRANTY IS IN LIEU OF ALL OTHER WARRANTIES, EXPRESSED OR IMPLIED, INCLUDING BUT NOT LIMITED TO THE IMPLIED WARRANTIES OF MERCHANTABILITY AND FITNESS FOR A PARTICULAR PURPOSE, WHICH ARE EXPRESSLY DISCLAIMED. THERE ARE NO WARRANTIES THAT EXTEND BEYOND THE FACE HEREOF. IF THIS DISCLAIMER IS NOT ENFORCEABLE UNDER STATE LAW, THEN, AL-KO LIMITS ALL IMPLIED WARRANTIES, INCLUDING, WITHOUT LIMITATION, MERCHANTABILITY AND FITNESS FOR A PARTICULAR PURPOSE TO THE APPLICABLE WARRANTY PERIOD. No person has authority to enlarge, amend or modify this warranty, nor is AL-KO responsible for any promises or representations beyond those expressed in this written document.

EXCLUSIONS: The following items are specifically excluded from coverage by the terms of this Limited Warranty: damage or defects which result from accident, collision, abuse, normal wear and tear, neglect, improper use, improper maintenance, improper installation, improper alignment, improper wheel nut torque, hub imbalance or any damage caused thereby, alteration or overloading, wiring, attachments of running gear to frame, parts not manufactured by AL-KO, i.e., brakes, alteration of the axle, improper mounting of the axle assembly, failure to follow routine maintenance, failure to repack the bearings, improper welding of spring seats, unauthorized repairs, and reinstallation of axle assembly on a different unit.

AL-KO'S OBLIGATIONS: AL-KO's obligations and undertakings in this warranty are limited to the repair or replacement, at its option, of any defective axles manufactured by AL-KO. IN NO EVENT SHALL AL-KO BE LIABLE FOR INCIDENTAL, INDIRECT AND CONSEQUENTIAL COSTS OR DAMAGES, INCLUDING LOSS OF USE OR ANY OTHER DAMAGES OF ANY TYPE CAUSED BY OR ARISING OUT OF SUCH DEFECTIVE PARTS OR PRODUCTS. If AL-KO determines there is a failure to conform to this Limited Warranty, AL-KO will replace or repair any defective products within a reasonable period of time, subject to availability of parts and scheduling. Any replacement parts will be sent to you at AL-KO's expense. You are responsible for all charges incurred for the installation of the replacement axle assembly. All repairs must first be authorized by AL-KO. In no event shall AL-KO be liable for repair costs in excess of its normal cost of repair performed by AL-KO or an approved service person. AL-KO's failure to adhere to exact terms of this written Warranty in any particular case does not constitute a waiver of any of its rights under this Warranty.

CUSTOMER'S OBLIGATIONS: In the event you believe any product manufactured by AL-KO has a defect or malfunction or failure to conform to this written warranty, you should contact AL-KO at its service location: 21611 Protecta Drive, Elkhart, IN 46516, (574) 294-6651.

All warranty claims shall be handled in accordance with the following procedure:

1. Contact AL-KO at the above location.
2. A "Returned Merchandise Authorization" (RMA) number will be assigned to you.
3. Return the product to AL-KO at the service location chosen by you, freight prepaid. PLEASE RETURN ONLY THE DEFECTIVE PART OR PARTS AS DIRECTED WITH APPROPRIATE PRECAUTIONS AGAINST DAMAGE.
4. Supply the following information with the returned merchandise:
 - (a) Name, address, and telephone number of the original purchaser of the product and include the date of purchase.
 - (b) Serial number and model or make of unit to which the axle is attached.
 - (c) Serial number of the axle itself.

If AL-KO determines there is no failure to conform to this Limited Warranty, you will be notified to retrieve your product from the service facility. AL-KO assumes no responsibility for merchandise not retrieved within thirty (30) days of notification to the original purchaser or owner of the product.

Some states do not allow a limitation on how long an implied warranty lasts or the exclusion or limitation of incidental or consequential damages or implied warranties. So the above limitations may not apply to you. In addition, you may have other rights which vary from state to state. Any terms of this warranty which conflict with the laws of your state are deemed amended by the law of your state. This warranty has been drafted to comply with Federal legislation and rules promulgated by the Federal Trade Commission. You may have additional legal rights in addition to those set forth in this written Limited Warranty.

LIMITATION: No action to enforce this Limited Warranty shall be commenced later than three (3) months after the expiration of the Warranty Period.

Service Record

Note: Reference pg. 11 for maintenance schedule recommendations

	Service Center:	Work Order#:
Date:	Service Performed:	
Mileage:		

	Service Center:	Work Order#:
Date:	Service Performed:	
Mileage:		

	Service Center:	Work Order#:
Date:	Service Performed:	
Mileage:		

	Service Center:	Work Order#:
Date:	Service Performed:	
Mileage:		

	Service Center:	Work Order#:
Date:	Service Performed:	
Mileage:		

	Service Center:	Work Order#:
Date:	Service Performed:	
Mileage:		